

Delivering leading edge, innovative power solutions for more than 30 years....

Model:GT-46240-24VV-x.x-T2

July 24, 2021

## GT-46240-24VV-x.x-T2

### Information

#### Model Number

GT-46240-24VV-x.x-T2

#### Description

GT-46240-24VV-x.x-T2, ICT/ITE Power Supply, Desktop/External, Regulated Switchmode AC-DC Power Supply AC Adaptor, , Input Rating: 100-240V~, 50-60 Hz, IEC 60320/C8 AC Inlet connector, Class II, Non-Earth Ground (aka "Figure-8"), Output Rating: 24 Watts, Power rating with convection cooling (W) , 12-24V in 0.1V increments, Approvals: cULus; 230V CoC Tier 2; EAC; SIQ; cULus; UKCA; PSE; RCM; cETLus 62368-1; Morocco; CB 62368; CE; China RoHS; IP42; Level VI; LPS 60950; PSE; RoHS; Ukraine; VCCI; WEEE; Double Insulation; CB 60950; SAA;

#### Model Picture

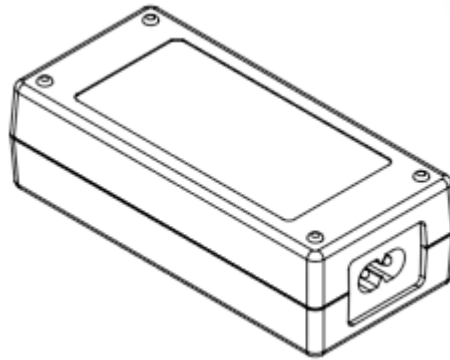

#### Agency Documents

<http://www.globtek.info/certs/GT-46240-24VV-x.x-T2/>

#### CE EC-Declaration

[https://www.globtek.com/pdf/ec\\_declaration/a0Oa000000MnJ4QEAV](https://www.globtek.com/pdf/ec_declaration/a0Oa000000MnJ4QEAV)

#### RoHS/RoHS2 Declaration

[https://www.globtek.com/pdf/rohs\\_cert/a0Oa000000MnJ4QEAV](https://www.globtek.com/pdf/rohs_cert/a0Oa000000MnJ4QEAV)

#### REACH Declaration

[https://www.globtek.com/pdf/iso\\_certificates/REACH.pdf](https://www.globtek.com/pdf/iso_certificates/REACH.pdf)

#### Conflict Minerals Declaration

<https://www.globtek.com/pdf/conflict-minerals.pdf>

Delivering leading edge, innovative power solutions for more than **30** years....

Model:GT-46240-24VV-x.x-T2

July 24, 2021

**MODEL PARAMETERS**

Type	Desktop/External
Technology	Regulated Switchmode AC-DC Power Supply AC Adaptor
Category	ICT/ITE Power Supply
Input Voltage	100-240V~, 50-60 Hz
I/P Amps (A)	0.6 A
Wattage (W)	24.0
Vout Range (V)	12-24
Efficiency Level	USA DOE Level VI / Eco-design Directive 2009/125/EC, (EU) 2019/1782
Ingress Protection	IP42
Size (mm)	80.6*50.0*31.0

Delivering leading edge, innovative power solutions for more than 30 years....

Model:GT-46240-24VV-x.x-T2

July 24, 2021

## ENCLOSURE

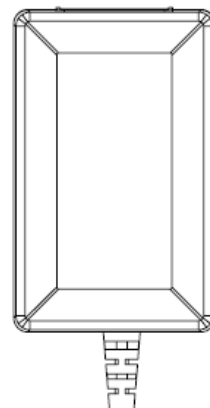
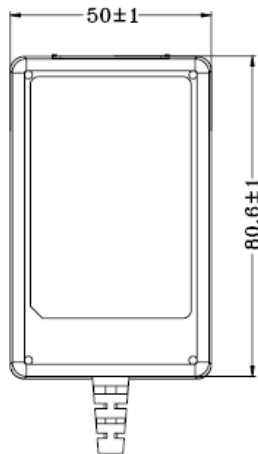
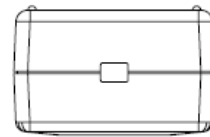
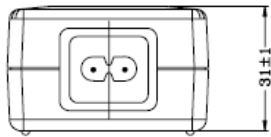

Delivering leading edge, innovative power solutions for more than **30** years....

Model:GT-46240-24VV-x.x-T2

July 24, 2021

## RATING TABLE

Model Number	Voltage	Amps(A)	Watts(W)	RFQ
GT-46240-2412-T2	12 V	2	24.00	<a href="#">RFQ</a>
GT-46240-2415-T2	15 V	1.6	24.00	<a href="#">RFQ</a>
GT-46240-1824-6.0-T2	18 V	1	18.00	<a href="#">RFQ</a>
GT-46240-2424-6.0-T2	18 V	1.33	23.94	<a href="#">RFQ</a>
GT-46240-2424-5.0-T2	19 V	1.26	23.94	<a href="#">RFQ</a>
GT-46240-2424-T2	24 V	1	24.00	<a href="#">RFQ</a>

Model:GT-46240-24VV-x.x-T2

July 24, 2021

## SPECIFICATIONS

### A) ELECTRICAL SPECIFICATIONS:

01. Input Voltage: Specified 90-264 Vac, Nameplate rated: 100-240Vac
02. Input Frequency: Specified 47-63 Hz, Nameplate rated 50-60Hz
03. Inrush Current: 50A Max. at 115VAC cold start, 100A Max. at 230VAC cold start
04. Average Efficiency: 86.2% Min (CEC & DOE LEVEL VI Compliant); 86.8% Min (ErP European Commission's Ecodesign Directive (2005/32/EC) / CoC Tier 2 Compliant)
05. Input Power(no load): <0.1W (CEC & DOE Level VI Compliant); <0.075W ErP European Commission's Ecodesign Directive (2005/32/EC) / CoC Tier 2 Compliant)
06. Output Voltage tolerance:  $\pm 5\%$
07. Load regulation:  $\pm 5\%$
08. Output Voltage: Tolerance  $\pm 5\%$
09. Turn On Delay: 3000 mS MAX at 115 VAC Full Load
10. Hold Up Time: 10 mS Min at 100 VAC Full Load
11. Ripple and Noise (Vp-p): 100 mVp-p maximum, At 20 MHz, and output parallel with 0.1uF & 47uF capacitors to ground. Temperature at 25 °C, and nominal input voltage

### B) PROTECTION

01. Over voltage protection: protection zener
02. Short circuit protection: Output shut down and auto- recover
03. Over Load Protection: Output shut down and auto restart

### C) SAFETY

01. HI-POT : Input to output : 1500VAC or 2121VDC 10mA 1 minute
02. Earth Leakage Current: <3.5 mA at 240Vac input voltage
03. Insulation resistance: Input to output: 500vdc to test the input to output resistance not be less 100M ohm
04. Earth continuity test:<0.1 Ohm or < 0.2 Ohm when with a non-detachable Power Supply cord, Class I Only

### D) OTHER:

01. MTBF: 200,000 Hours @ 25°C ambient temperature
02. Operating Temperature: 0°C to 40°C ambient temperature
03. Humidity Operating : 20% to 80%. 0% to 90% relative humidity
04. Storage Temperature: -10°C to 70°C  
Humidity Storage: 10% to 90%
05. RoHS 2: Complies with EU 2011/65/EU and China SJ/T 11364-2014

### E) ENCLOSURE

01. Housing: High impact plastic, 94V0 polycarbonate, non-vented
02. Size: 80.6\*50.0\*31.0 +/-1.0 mm
03. Markings: Label and/or Pad Printed and/or Molded in the case

Delivering leading edge, innovative power solutions for more than 30 years....

Model:GT-46240-24VV-x.x-T2

July 24, 2021

## DERATING CURVE

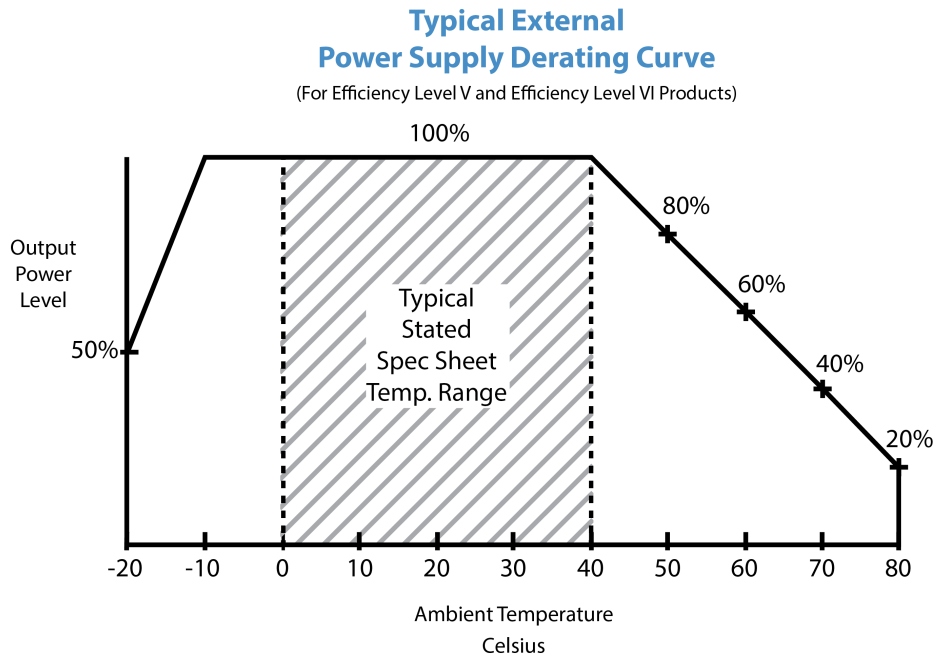

Delivering leading edge, innovative power solutions for more than 30 years....

Model:GT-46240-24VV-x.x-T2

July 24, 2021

**INPUT CONFIGURATION**

Description IEC 60320/C8 AC Inlet connector, Class II, Non-Earth Ground (aka "Figure-8")

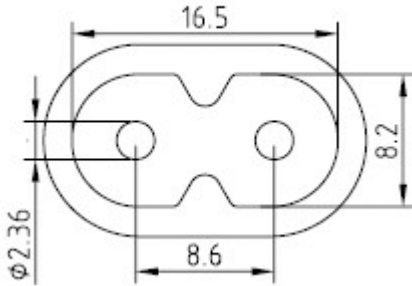

Mates with IEC 60320/C7 Plug

Below are standard cordsets which are "not included" (unless stated above); these may be purchased separately or packaged with the power supply. Please contact your Sales Engineer if the style required is not shown below. Many more available in different lengths, colors or cable material.

[Standard International IEC 320/C7 Cordsets](#)

Part Number	Type	Standard	Connector	Length (mm)	Length (feet)
<a href="#">2094112M703(R)</a>	Argentina (Type I)	IRAM 2063	IEC 320/C7	2000	7
<a href="#">5014112M703A(R)</a>	Australian (Type I)	AS 3112	IEC 320/C7	2000	7
<a href="#">207B4111M8703(R)</a>	Brazil (Type N)	NBR14136	IEC 320/C7	1800	6
<a href="#">4533501M8703(R)</a>	China (Type A)	GB 2099.1	IEC 320/C7	1830	6
<a href="#">2074112M703A(R)</a>	European (Type C)	CEE 7/16	IEC 320/C7	2000	7
<a href="#">2084111M8703B(R)</a>	India (Type D)	IS 1293	IEC 320/C7	1800	6
<a href="#">451J3401M8703(R)</a>	Japan (Type A)	JIS 8303	IEC 320/C7	1830	6
<a href="#">2044112M703A(R)</a>	Korea (Type C)	KS C8305	IEC 320/C7	2000	7
<a href="#">4511116F703A(R)</a>	North America (Type A)	NEMA 1-15P	IEC 320/C7	1830	6
	South Africa (Type				

Delivering leading edge, innovative power solutions for more than **30** years....

Model:GT-46240-24VV-x.x-T2

July 24, 2021

<a href="#">2084111M8703(R)</a>	M)	BS 546	IEC320/C7	1830	6
<a href="#">4033401M8703A(R)</a>	Taiwan (Type A)	CNS690	IEC 320/C7	1830	6
<a href="#">6104112M703A(R)</a>	UK, Hong Kong, Singapore, Gulf States (Type G)	BS1363	IEC 320/C7	2000	7
<a href="#">451G1116F703A(R)</a>	Gulf States (Kuwait, Bahrain, Oman, Qatar, Saudi Arabia, Yemen and the United Arab Emirates (UAE)(Type A)	Nema 1-15P	IEC320/C7	1830	6



Delivering leading edge, innovative power solutions for more than 30 years....

Model:GT-46240-24VV-x.x-T2

July 24, 2021

**OUTPUT CONFIGURATION**

Common output connector options:

 L Type (Coaxial  
5.5x2.5mm plug)

 C Type (Coaxial  
5.5x2.1mm plug)

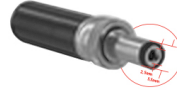
 K Type (Coaxial  
3.5x1.3mm plug)

 LL Type (5.5x2.5mm  
Locking 760k type)

 CL Type (5.5x2.1mm  
Locking S761k type)

 ML2 Type (Molex  
housing 43025-0200)

 YL3 Type  
(KPPX-3P)

YL4 Type (KPPX-4P)

 EJ1/2/3/4/5 (EIAJ  
RC-5320A type  
connectors)

 MSB Type (Micro  
USB)

 USBC Type (USB  
Type C)

 Inquire for custom  
design

 For a comprehensive list of options, [click here](#)







Contact GlobTek for your specific requirements or custom solutions.

Delivering leading edge, innovative power solutions for more than **30** years....

Model:GT-46240-24VV-x.x-T2

July 24, 2021









## Approvals

Logo	Description
No Logo Applicable	EU 230V CoC Tier 2, 278/2009, Mar 2014
No Logo	CB Report IEC 60950-1:2005 (Second Edition) + Am 1:2009 + Am 2:2013 (GT-46240 only)
No Logo Applicable	CB for IEC 62368-1:2014 (Second Edition) + A11:2017
	CE Certification
	CHINA SJ/T 11364-2014, China RoHS Chart: <a href="http://en.globtek.com/globtek-rohs.php">http://en.globtek.com/globtek-rohs.php</a>
Conforms to UL STD. 62368-1 Certified to CSA STD C22.2 NO.62368-1	Conforms to UL STD. 62368-1 Certified to CSA STD C22.2 NO.62368-1
	UL 60950-1, 2nd Edition, 2014-10-14 (Information Technology Equipment - Safety - Part 1: General Requirements) CAN/CSA C22.2 No. 60950-1-07, 2nd Edition, 2014-10 (Information Technology Equipment - Safety - Part 1: General Requirements)
	
	Declaration ДС № EAЭC N RU Д-US.KA01.B.10453_19 Custom Union of Russia, Belarus and Kazakhstan <a href="http://www.globtek.com/redirect/?loc=gost-certificate-eac-declaration">http://www.globtek.com/redirect/?loc=gost-certificate-eac-declaration</a>
	Indoor Use Only - Mark is on the label or Molded in the case
IP42	Ingress Protection: ?IP42 to IEC60529:2001 Protection against granular foreign bodies - Protected against direct sprays up to 15o from the vertical Optional

Delivering leading edge, innovative power solutions for more than 30 years....

Model:GT-46240-24VV-x.x-T2



July 24, 2021

 GlobTek, Inc.	JAPAN TUV R-PSE, Cert. No. JD 50471561.pdf, to J62368-1(H30) , J55032(H29), J3000(H25) ,[15V?30V]. Please reference the following website for PSE regulations: <a href="http://en.globtek.com/importing-ite-and-medical-power-supplies-ac-adaptors-to-japan/">http://en.globtek.com/importing-ite-and-medical-power-supplies-ac-adaptors-to-japan/</a>
 GlobTek, Inc.	JAPAN TUV R-PSE, Cert. No. JD 50471561, to J62368-1(H30) , J55032(H29), J3000(H25) ,[15V or less]. Please reference the following website for PSE regulations: <a href="http://en.globtek.com/importing-ite-and-medical-power-supplies-ac-adaptors-to-japan/">http://en.globtek.com/importing-ite-and-medical-power-supplies-ac-adaptors-to-japan/</a>
<b>EFFICIENCY LEVEL VI</b>	Efficiency: complies to section 301 of Energy Independence and Security Act (EISA) complies with Energy Star tier 2 (North America), ECP tier 2 (China), MEPS tier 2 (Australia), Code of Conduct (Europe)
LPS	Limited Power Source 60950
	Morocco SDoC declaration <a href="http://www.globtek.info/certs/Morocco%20SDoC%20Declaration/">http://www.globtek.info/certs/Morocco%20SDoC%20Declaration/</a>
 <b>N136</b> SAA-210577-EA	RCM certificate SAA-210577-EA; Australia and New Zealand Regulatory Compliance, Mark ( <a href="http://rcm.standards.org.au/rcmfaq/rcmfaq.htm">http://rcm.standards.org.au/rcmfaq/rcmfaq.htm</a> )
RoHS	Specifications of directive 2011/65/EU Annex VI (ROHS-2) with amendment 2015/863-EU (ROHS-3) <a href="http://www.ce-mark.com/Rohs%20final.pdf">http://www.ce-mark.com/Rohs%20final.pdf</a>
 <b>N136</b> SAA-210577-EA	RCM certificate SAA-210577-EA; Australia and New Zealand Regulatory Compliance, Mark ( <a href="http://rcm.standards.org.au/rcmfaq/rcmfaq.htm">http://rcm.standards.org.au/rcmfaq/rcmfaq.htm</a> )
	SIQ Mark EN 62368-1:2014 + All:2017
	UKCA Certification
 10276	Ukraine UKRSepr (Document: <a href="http://www.globtek.com/html/iso_certificates/GT_Ukraine.pdf">www.globtek.com/html/iso_certificates/GT_Ukraine.pdf</a> )

Delivering leading edge, innovative power solutions for more than **30** years....

Model:GT-46240-24VV-x.x-T2

July 24, 2021

	UL 62368-1 and CAN/CSA C22.2 No. 62368-1-14
	Japan: Voluntary Control Council for Interference (VCCI)
	WEEE: Complies with EU 2012/19/EU ( <a href="http://ec.europa.eu/environment/waste/weee/index_en.htm">http://ec.europa.eu/environment/waste/weee/index_en.htm</a> ) Mark is on the label or Molded in the case