

Delivering leading edge, innovative power solutions for more than **30** years....

Model:GTM961200P120VV.V-T2

July 24, 2021

GlobTek's GTM961200 series of external tabletop/desktop power supplies offer up to 120W of power while offering compliance to the latest ITE, Medical, Household, and Efficiency requirements, Class II

**Information**

Model Number	GTM961200P120VV.V-T2
Description	120 W, DoE Level VI & CoC Tier 2 Efficiency, Two Prong (C8) Inlet, Desktop Adapter, Ac-Dc Power Supply

**Model Picture**

Agency Documents	<a href="http://www.globtek.info/certs/GTM961200P/">http://www.globtek.info/certs/GTM961200P/</a>
CE EC-Declaration	<a href="https://www.globtek.com/pdf/ec_declaration/a0Oa000000MmWwCEAV">https://www.globtek.com/pdf/ec_declaration/a0Oa000000MmWwCEAV</a>
RoHS/RoHS2 Declaration	<a href="https://www.globtek.com/pdf/rohs_cert/a0Oa000000MmWwCEAV">https://www.globtek.com/pdf/rohs_cert/a0Oa000000MmWwCEAV</a>
REACH Declaration	<a href="https://www.globtek.com/pdf/iso_certificates/REACH.pdf">https://www.globtek.com/pdf/iso_certificates/REACH.pdf</a>
Conflict Minerals Declaration	<a href="https://www.globtek.com/pdf/conflict-minerals.pdf">https://www.globtek.com/pdf/conflict-minerals.pdf</a>

Delivering leading edge, innovative power solutions for more than **30** years....

Model:GTM961200P120VV.V-T2

July 24, 2021

**MODEL PARAMETERS**

Type	Desktop/External
Technology	Regulated Switchmode AC-DC Power Supply AC Adaptor
Category	ICT / ITE / Medical Power Supply
Input Voltage	100-240V~, 50-60 Hz
I/P Amps (A)	1.5 A
Wattage (W)	120.0
Vout Range (V)	12-54
Efficiency Level	USA DOE Level VI / Eco-design Directive 2009/125/EC, (EU) 2019/1782
Ingress Protection	IP41
Size (mm)	149.30*62.80*34.00

**PROPRIETARY INFORMATION**

PROPRIETARY OF GLOBTEK, INC. ANY REPRODUCTION, DISCLOSURE OR USE OF THIS DRAWING, IN WHOLE OR IN PART, IS HEREBY PROHIBITED EXCEPT AS SPECIFIED IN WRITING BY GLOBTEK, INC.

<https://en.globtek.com/datasheet/id/a0Oa000000MmWwC>

Delivering leading edge, innovative power solutions for more than 30 years....

Model:GTM961200P120VV.V-T2

July 24, 2021

**ENCLOSURE**

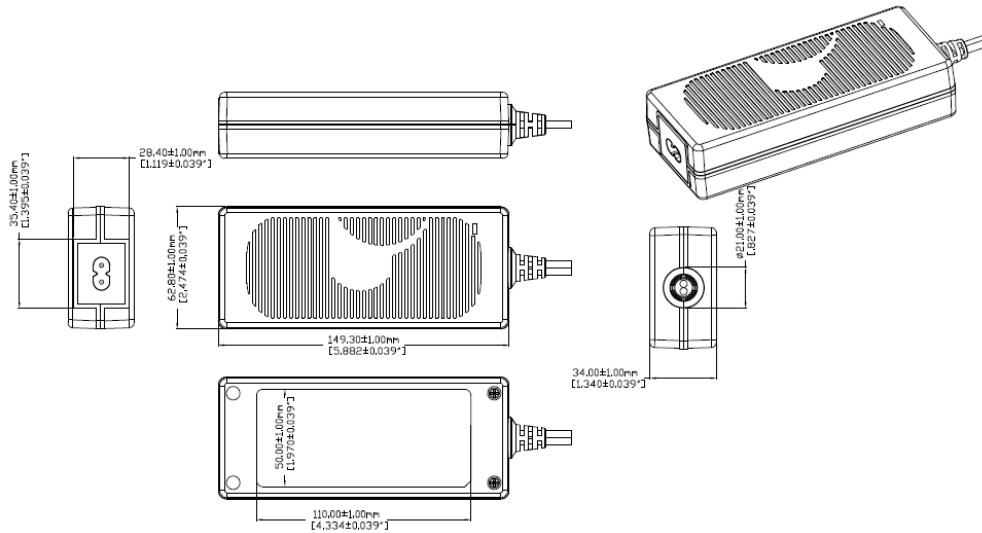

Alternative housing with input cord clamp to prevent accidental removal of the power cord. Product PN# ends with suffix "CL"

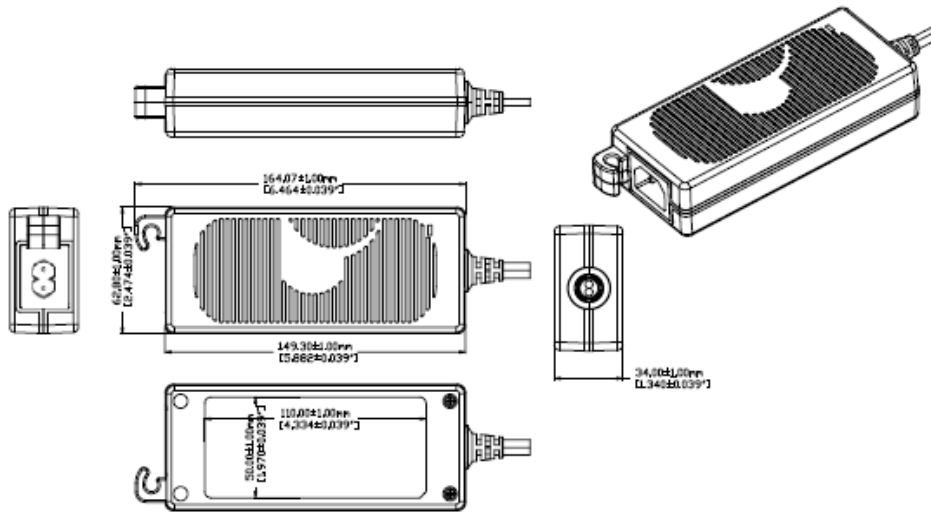

Delivering leading edge, innovative power solutions for more than **30** years....

Model:GTM961200P120VV.V-T2

July 24, 2021

**RATING TABLE**

Model Number	Voltage	Amps(A)	Watts(W)	RFQ
GTM961200P11012-T2	12 V	9.2	110.40	<a href="#">RFQ</a>
GTM961200P12015-T2	15 V	8	120.00	<a href="#">RFQ</a>
GTM961200P12018-T2	18 V	6.66	119.88	<a href="#">RFQ</a>
GTM961200P12019-T2	19 V	6.31	119.89	<a href="#">RFQ</a>
GTM961200P12024-T2	24 V	5	120.00	<a href="#">RFQ</a>
GTM961200P12036-T2	36 V	3.33	119.88	<a href="#">RFQ</a>
GTM961200P12048-T2	48 V	2.5	120.00	<a href="#">RFQ</a>
GTM961200P12054-T2	54 V	2.22	119.88	<a href="#">RFQ</a>

Delivering leading edge, innovative power solutions for more than 30 years....

Model:GTM961200P120VV.V-T2

July 24, 2021

## SPECIFICATIONS

### Input

Input Voltage:	Specified: 90-264VAC, Nameplate: 100-240VAC 100% rated load current for 90-264VAC 90% rated load current for 85-264VAC 100% rated load current for 90-370VDC
Input Frequency:	Specified: 47-63Hz, Nameplate: 50-60Hz
Power Factor:	0.90 min. @ 230VAC, 0.97 min. @ 115VAC
No Load Input Power:	< 150mW @ 115/230VAC
Inrush Current:	< 65A @ 115VAC, < 130A @ 230VAC (cold start)
Efficiency:	DoE Level VI and EU CoC Tier 2 compliant

### Output

Turn-on Delay:	1 second typ.
Output Regulation:	± 4% (measured at output connector)
Line Regulation:	± 0.5% typ. (measured at output connector, full load)
Ripple:	1% or 200mV, whichever is greater (using a 47µF low-ESR cap + 0.1µF ceramic capacitor, measured @ 20MHz BW, at output connector)
Startup Overshoot:	5% max.
Transient Response:	5% max. deviation, 1ms typ. recovery time (with 25% to 50% load step)
Hold-up Time:	20ms min.
Power Indicator:	Green LED
Switching Frequency:	Variable, 25KHz - 125KHz, depending on load

### Protections

Input Protection:	300VAC MOV transient suppressor, input line fusing
Over-Current Protection	Current limited to less than $< 170W / V_{out(nom.)}$ and $< 13A$ , auto-restart
Short-Circuit Protection:	Auto-restart
Over-Voltage Protection:	110 - 135% (60V max for models rated 45 - 54V), full load condition, latched off, cycle AC to reset
Over-Temperature Protection	Internal ambient NTC temperature sensor, latched off, cycle AC to reset

### Environmental

MTBF:	1,500,000 hours @ 25°C ambient, full load (Telcordia SR-332, Issue 3)
Operating Temperature:	-10°C to 40°C (full load)
Storage Temperature:	-30°C to 80°C

Delivering leading edge, innovative power solutions for more than 30 years....

Model:GTM961200P120VV.V-T2

July 24, 2021

Humidity:	0% to 95% relative humidity, non-condensing
Altitude:	5000m
Cooling:	Convection
RoHS:	Complies with EU 2011/65/EU and China SJ/T 11363-2006
Note 1:	Regarding operating temperature a. See below de-rating table for output power capability at alternate temperature b. Extended low-end temperature range available as a custom option

## Safety

Dielectric Withstand Voltage:	4000VAC or 5656VDC from input to output 3000VAC or 4242VDC from input to earth (Class I models only)
Touch Current:	Class I: 20µA max. Class II: 70µA max.
Earth Leakage Current	Class I: 300µA max. Class II: N/A
Means of Protection:	2 x MOPP
Output Isolation Options:	Class I: C6 or C14 inlet (output negative tied to Earth contact) Class II: C8 or C18 inlet Class II FE: C6 or C14 inlet (output isolated from Earth contact) Review isolation options by reading our white paper <a href="#">PSU Isolation and Identity</a> .
Primary-to-Secondary Bridging Capacitors:	Two IEC60384-14 Class Y1 capacitors
Earth Continuity Test:	< 0.1Ω between earth pin (on AC inlet) and PCB termination point (Class I models only)
Compliant Standards:	See listing at end of this datasheet for specific standards

## EMC

Applicable Standards:	Medical: EN60601-1-2, 4th edition Emissions: EN55032, EN61000-6-3, EN61000-6-4, CISPR11, CISPR22 Immunity: EN55024, EN61000-6-1, EN61000-6-2
Conducted Emissions:	Class B, FCC Part 15, Class B (with resistive load)
Radiated Emissions:	Class B, FCC Part 15, Class B (with resistive load)
Harmonic Current Voltage Distortion:	EN61000-3-2, Class A
Voltage Fluctuations/Flicker:	EN61000-3-3
Electrostatic Discharge (ESD) Immunity:	EN61000-4-2, 10KV contact discharge, 18KV air discharge
Radiated RF Immunity:	EN61000-4-3, 10V/m 80-1000MHz, 3V/m 1-2.7GHz, 80% 1KHz AM
EFT/Burst Immunity:	EN61000-4-4, 4KV/100kHz.
Line Surge Immunity:	EN61000-4-5, 2KV differential, 4KV common-mode
Conducted RF Immunity:	EN61000-4-6, 3VRMS, 80% 1KHz AM
Power Frequency Magnetic Field Immunity:	EN61000-4-8, 3A/m
Voltage Dip Immunity:	EN61000-4-11

Delivering leading edge, innovative power solutions for more than 30 years....

Model:GTM961200P120VV.V-T2

July 24, 2021

## Enclosure

Housing:	High impact plastic, 94V0 polycarbonate, non-vented
Size:	149.4 * 62.6 * 33.5mm, ± 1.0mm
AC Input Mechanical Options:	C6, C8, C14, or C18 IEC inlet
Markings:	Label and/or pad printed and/or laser-etched into case

## Special Options

1. Reduced leakage current to meet IEC60601-1 Type-CF limits
2. Improved EN61000-4-5 line surge immunity (3KV differential, 5KV common-mode)
3. Reduced harmonic current levels for LED lighting (EN61000-3-2 Class C) for 85 - 120W load
4. Short term output surge capability for motors or other high peak current loads
5. Ruggedized construction with improved shock and vibration resistance
6. Compliance to IPC-600, IPC-610, IPC-6012 Class 2 or 3
7. Custom cordsets, special cordage and connector types
8. Custom housing markings
9. Custom housing/cordage colors
10. Tightened output voltage tolerance
11. Reduced output ripple level
12. Reduced output power rating
13. Low temperature option, down to -40°C
14. Epoxy potted version "P2" or "P3" suffix, with flying wires or custom cables
15. "Back EMF" upgrade, for motor loads and other high inductance applications with reverse energy flow requirements
16. Improved ingress protection (IP) rating

## Output Connectors

- Several output connector options are available with various output current ratings. GlobTek can supply 10A rated 2.1mm and 2.5mm style DC Power Jacks, to complement our 10A output rated 2.1mm and 2.5mm DC power plugs used on our output cordsets.
- Please visit our real-time listing of mating connector product offering:  
<https://en.globtek.com/news/high-current-coaxial-barrel-plug-jacks-for-high-wattage-power-supplies>

Delivering leading edge, innovative power solutions for more than 30 years....

Model:GTM961200P120VV.V-T2

July 24, 2021

## DERATING CURVE

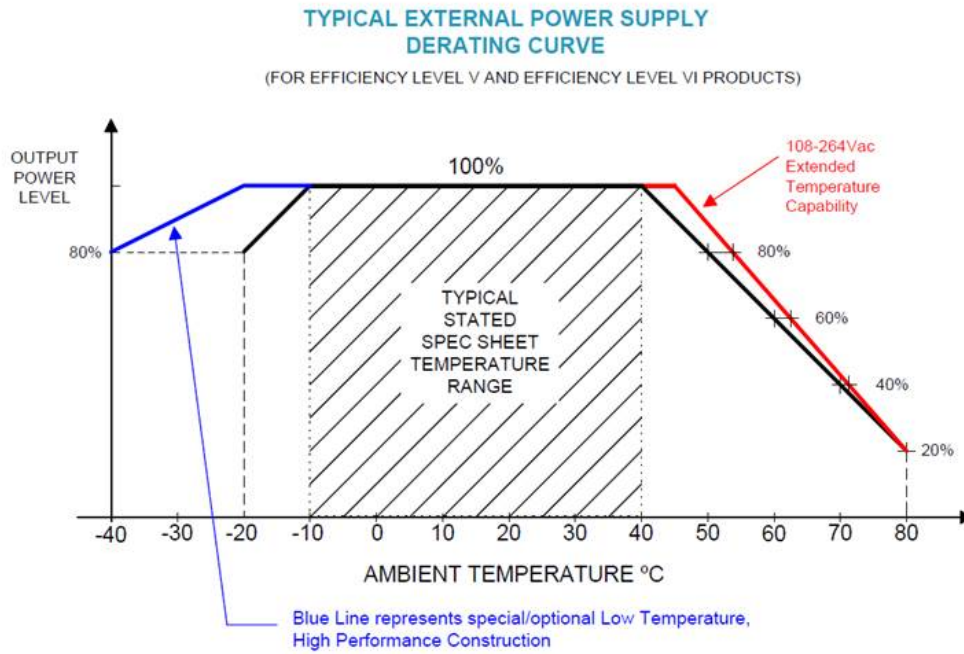



Delivering leading edge, innovative power solutions for more than 30 years....

Model:GTM961200P120VV.V-T2

July 24, 2021

**INPUT CONFIGURATION**

Description IEC 60320/C8 AC Inlet connector, Class II, Non-Earth Ground (aka "Figure-8")

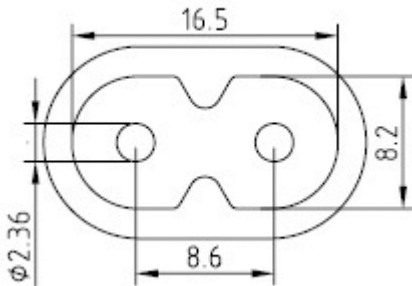

Mates with IEC 60320/C7 Plug

Below are standard cordsets which are "not included" (unless stated above); these may be purchased separately or packaged with the power supply. Please contact your Sales Engineer if the style required is not shown below. Many more available in different lengths, colors or cable material.

[Standard International IEC 320/C7 Cordsets](#)

Part Number	Type	Standard	Connector	Length (mm)	Length (feet)
<a href="#">2094112M703(R)</a>	Argentina (Type I)	IRAM 2063	IEC 320/C7	2000	7
<a href="#">5014112M703A(R)</a>	Australian (Type I)	AS 3112	IEC 320/C7	2000	7
<a href="#">207B4111M8703(R)</a>	Brazil (Type N)	NBR14136	IEC 320/C7	1800	6
<a href="#">4533501M8703(R)</a>	China (Type A)	GB 2099.1	IEC 320/C7	1830	6
<a href="#">2074112M703A(R)</a>	European (Type C)	CEE 7/16	IEC 320/C7	2000	7
<a href="#">2084111M8703B(R)</a>	India (Type D)	IS 1293	IEC 320/C7	1800	6
<a href="#">451J3401M8703(R)</a>	Japan (Type A)	JIS 8303	IEC 320/C7	1830	6
<a href="#">2044112M703A(R)</a>	Korea (Type C)	KS C8305	IEC 320/C7	2000	7
<a href="#">4511116F703A(R)</a>	North America (Type A)	NEMA 1-15P	IEC 320/C7	1830	6
	South Africa (Type				

Delivering leading edge, innovative power solutions for more than **30** years....

Model:GTM961200P120VV.V-T2

July 24, 2021

<a href="#">2084111M8703(R)</a>	M)	BS 546	IEC320/C7	1830	6
<a href="#">4033401M8703A(R)</a>	Taiwan (Type A)	CNS690	IEC 320/C7	1830	6
<a href="#">6104112M703A(R)</a>	UK, Hong Kong, Singapore, Gulf States (Type G)	BS1363	IEC 320/C7	2000	7
<a href="#">451G1116F703A(R)</a>	Gulf States (Kuwait, Bahrain, Oman, Qatar, Saudi Arabia, Yemen and the United Arab Emirates (UAE)(Type A)	Nema 1-15P	IEC320/C7	1830	6

Delivering leading edge, innovative power solutions for more than 30 years....

Model:GTM961200P120VV.V-T2

July 24, 2021

**OUTPUT CONFIGURATION**

Common output connector options:

 L Type (Coaxial  
5.5x2.5mm plug)

 C Type (Coaxial  
5.5x2.1mm plug)

 K Type (Coaxial  
3.5x1.3mm plug)

 LL Type (5.5x2.5mm  
Locking 760k type)

 CL Type (5.5x2.1mm  
Locking S761k type)

 ML2 Type (Molex  
housing 43025-0200)

 YL3 Type  
(KPPX-3P)

YL4 Type (KPPX-4P)

 EJ1/2/3/4/5 (EIAJ  
RC-5320A type  
connectors)

 MSB Type (Micro  
USB)

 USBC Type (USB  
Type C)

 Inquire for custom  
design

 For a comprehensive list of options, [click here](#)

Contact GlobTek for your specific requirements or custom solutions.

Model:GTM961200P120VV.V-T2

July 24, 2021









## Approvals

Logo	Description
No Logo Applicable	CB for IEC 60950-1:2005 (Second Edition) + Am 1:2009 + Am 2:2013
No Logo Applicable	CB for IEC 60601-1:2006/A1:2013+A12:2014 IEC 60601-1-11:2015
No Logo Applicable	CB for IEC 60335-1:2010 (Fifth Edition) incl. Corr. 1:2010 and Corr. 2:2011 + A1:2013
No Logo Applicable	IEC 60335-1.2010+A1
No Logo Applicable	CB for IEC61347-1:2015 + A1:2017 IEC61347-2-13:2014, A1:2016
No Logo Applicable	CB for IEC 62368-1:2014 (Second Edition)
	CCC Altitude up to 5000 m GB17625.1-2012, GB4943.1-2011, GB/T9254-2008
	CE Mark: tested to comply with EN55022:2006/A1:2007 Class B, EN610003-2, EN610003-3 including EN61000-4-2, EN61000-4-3, EN61000-4-4, EN61000-4-5, EN61000-4-6N EN61000-4-11; EMI: Complies with EN55011 CLASS B and FCC Part 15B - On label or Molded in case
	Audio/Video, Information And Communication Technology Equipment - Part 1: Safety Requirements [UL 62368-1:2014 Ed.2] Audio/Video, Information And Communication Technology Equipment - Part 1: Safety Requirements [CSA C22.2#62368-1:2014 Ed.2]
	CHINA SJ/T 11364-2014, China RoHS Chart: <a href="http://en.globtek.com/globtek-rohs.php">http://en.globtek.com/globtek-rohs.php</a>

Delivering leading edge, innovative power solutions for more than 30 years....

Model:GTM961200P120VV.V-T2









July 24, 2021

Conforms to UL STD. 62368-1 Certified to CSA STD C22.2 NO.62368-1	Conforms to UL STD. 62368-1 Certified to CSA STD C22.2 NO.62368-1
	
	Declaration ДС № EAЭC N RU Д-US.KA01.B.10453_19 Custom Union of Russia, Belarus and Kazakhstan <a href="http://www.globtek.com/redirect/?loc=gost-certificate-eac-declaration">http://www.globtek.com/redirect/?loc=gost-certificate-eac-declaration</a>
	Medical Electrical Equipment - Part 1: General Requirements For Basic Safety And Essential Performance (R2012) [AAMI ES60601-1:2005 +C1;A2] [CSA C22.2#60601-1:2014 Ed.3] [AAMI HA60601-1-11:2015 Ed.2]
	Information Technology Equipment Safety Part 1: General Requirements >Valid without technical revision: 01Jan2022< [UL 60950-1:2007 Ed.2 +R:14Oct2014]
	Indoor Use Only - Mark is on the label or Molded in the case
 <b>DC-E-G71-005.2</b>  PRECAUCION: PARA USO EN EQUIPOS ELECTRONICOS SOLAMENTE	IRAM certificateDC-E-G71-005.1 to IEC 62368-1:2014
 GlobTek, Inc.	JAPAN TUV R-PSE, Cert. No. JD 50313287, to J60950-1(H26) , J55022(H22),J3000(H25)[DC15?30V]. Please reference the following website for guidelines on PSE regulations: <a href="http://en.globtek.com/importing-ite-and-medical-power-supplies-ac-adaptors-to-japan/">http://en.globtek.com/importing-ite-and-medical-power-supplies-ac-adaptors-to-japan/</a>
 GlobTek, Inc.	JAPAN TUV R-PSE, Cert. No. JD 50313287, to J60950-1(H26) , J55022(H22),J3000(H25)[DC30?60V]. Please reference the following website for guidelines on PSE regulations: <a href="http://en.globtek.com/importing-ite-and-medical-power-supplies-ac-adaptors-to-japan/">http://en.globtek.com/importing-ite-and-medical-power-supplies-ac-adaptors-to-japan/</a>
	JAPAN TUV R-PSE, Cert. No. JD 50469658, to J62368-1(H30) ,

Delivering leading edge, innovative power solutions for more than 30 years....

Model:GTM961200P120VV.V-T2





July 24, 2021

 GlobTek, Inc.	J55032(H29),J3000(H25)[15V or less]. Please reference the following website for guidelines on PSE regulations: <a href="http://en.globtek.com/importing-ite-and-medical-power-supplies-ac-adaptors-to-japan/">http://en.globtek.com/importing-ite-and-medical-power-supplies-ac-adaptors-to-japan/</a>
EFFICIENCY LEVEL 	Efficiency: complies to section 301 of Energy Independence and Security Act (EISA) complies with Energy Star tier 2 (North America), ECP tier 2 (China), MEPS tier 2 (Australia), Code of Conduct (Europe)
No Logo	Malaysia ST Release Letter GTM41133 GTM96900P; GTM961200P T2 T3(A) IEC60950-1(Ed.2): 2005 + A1:2009 + A2:2013 No logo
	Morocco SDoC declaration <a href="http://www.globtek.info/certs/Morocco%20SDoC%20Declaration/">http://www.globtek.info/certs/Morocco%20SDoC%20Declaration/</a>
	Natural Resources Canada (NRCAN): CSA Standard C381.1-08, QSP NRCAN EEV1191; <a href="http://shop.csa.ca/en/canada/energy-efficiency/canca-c3811-08/inv/27024802008">http://shop.csa.ca/en/canada/energy-efficiency/canca-c3811-08/inv/27024802008</a>
 GlobTek, Inc.	JAPAN TUV Rheinland-PSE GlobTek Inc to J60950-1(H26) , J55022(H22),J3000(H25).Please follow the procedure listed in the following link for proper import to Japan: <a href="http://en.globtek.com/importing-to-japan.php">http://en.globtek.com/importing-to-japan.php</a> .
	RCM certificate SAA-170646-EA; Australia and New Zealand Regulatory Compliance, Mark ( <a href="http://rcm.standards.org.au/rcmfaq/rcmfaq.htm">http://rcm.standards.org.au/rcmfaq/rcmfaq.htm</a> )
RoHS	Specifications of directive 2011/65/EU Annex VI (ROHS-2) with amendment 2015/863-EU (ROHS-3) <a href="http://www.ce-mark.com/Rohs%20final.pdf">http://www.ce-mark.com/Rohs%20final.pdf</a>
	S-Mark Certificate EN 60601-1:2006 + A1:2013 + A12:2014 EN 60601-1-11:2015 <a href="http://www.intertek.com/marks/s/">http://www.intertek.com/marks/s/</a>
	S-Mark Certificate EN 60950-1:2006 + A11:2009 + A1:2010 + A12:2011+A2:2013 ( <a href="http://www.intertek.com/marks/s/">http://www.intertek.com/marks/s/</a> )

Delivering leading edge, innovative power solutions for more than **30** years....

Model:GTM961200P120VV.V-T2

July 24, 2021

 Intertek	S-Mark Certificate EN 62368-1:2014 + A11 ( <a href="http://www.intertek.com/marks/s/">http://www.intertek.com/marks/s/</a> )
	UKCA Certification
 10276	Ukraine UKRSePro (Document: <a href="http://www.globtek.com/html/iso_certificates/GT_Ukraine.pdf">www.globtek.com/html/iso_certificates/GT_Ukraine.pdf</a> )
	Japan: Voluntary Control Council for Interference (VCCI)
	WEEE: Complies with EU 2012/19/EU ( <a href="http://ec.europa.eu/environment/waste/weee/index_en.htm">http://ec.europa.eu/environment/waste/weee/index_en.htm</a> ) Mark is on the label or Molded in the case