

Delivering leading edge, innovative power solutions for more than 30 years....

Model:GT-46400-40VV-X.X-T3

July 24, 2021

DOE EPS 2.0 Level VI Power Supply / Charger / AC Adapter, 40W Desktop/Tabletop with Class I Input, Available with 12-24VDC output Certified to Medical and ITE Standards

Information

Model Number	GT-46400-40VV-X.X-T3
Description	40 W, DoE Level VI & CoC Tier 2 Efficiency, Three Prong (C14) Inlet, Desktop Adapter, Ac-Dc Power Supply

Model Picture

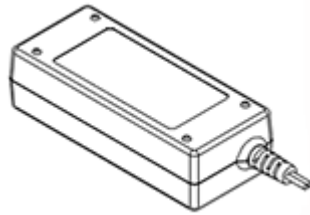

Agency Documents	http://www.globtek.info/certs/GT-46400-WVVV-X.X-TZ/
CE EC-Declaration	https://www.globtek.com/pdf/ec_declaration/a0Oa000000MikBiEAJ
RoHS/RoHS2 Declaration	https://www.globtek.com/pdf/rohs_cert/a0Oa000000MikBiEAJ
REACH Declaration	https://www.globtek.com/pdf/iso_certificates/REACH.pdf
Conflict Minerals Declaration	https://www.globtek.com/pdf/conflict-minerals.pdf

Delivering leading edge, innovative power solutions for more than **30** years....

Model:GT-46400-40VV-X.X-T3

July 24, 2021

MODEL PARAMETERS

Type	Desktop/External
Technology	Regulated Switchmode AC-DC Power Supply AC Adaptor
Category	ICT/ITE Power Supply
Input Voltage	100-240V~, 50-60 Hz
I/P Amps (A)	1.0A
Wattage (W)	40.0
Vout Range (V)	12-24
Efficiency Level	USA DOE Level VI / Eco-design Directive 2009/125/EC, (EU) 2019/1782
Ingress Protection	IPX0
Size (mm)	111*52*32.3

Delivering leading edge, innovative power solutions for more than 30 years....

Model:GT-46400-40VV-X.X-T3

July 24, 2021

ENCLOSURE

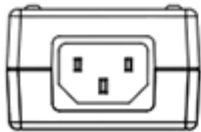
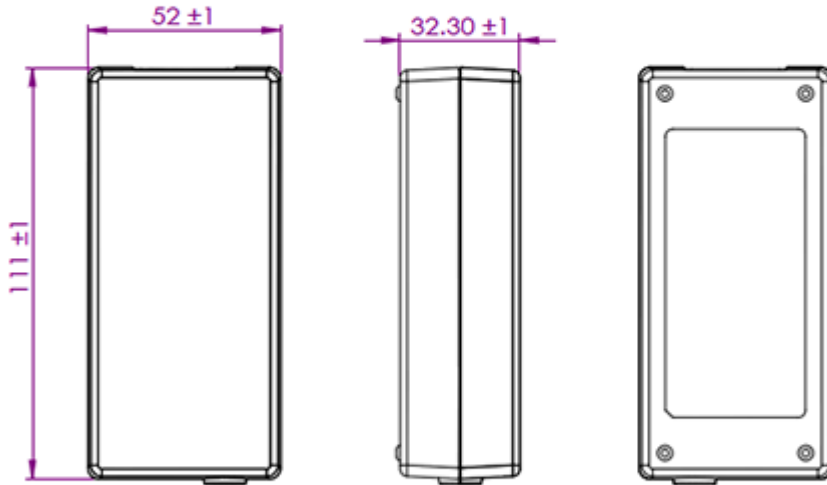
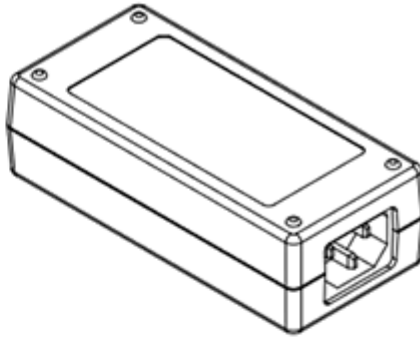
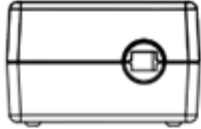

Delivering leading edge, innovative power solutions for more than **30** years....

Model:GT-46400-40VV-X.X-T3

July 24, 2021

RATING TABLE

Model Number	Voltage	Amps(A)	Watts(W)	RFQ
GT-46400-3612-T3	12 V	3	36.00	RFQ
GT-46400-3615-2.0-T3	13 V	2.77	36.01	RFQ
GT-46400-3615-1.0-T3	14 V	2.57	35.98	RFQ
GT-46400-4015-T3	15 V	2.66	39.90	RFQ
GT-46400-4019-3.0-T3	16 V	2.5	40.00	RFQ
GT-46400-4019-2.0-T3	17 V	2.35	39.95	RFQ
GT-46400-4019-1.0-T3	18 V	2.22	39.96	RFQ
GT-46400-4019-T3	19 V	2.1	39.90	RFQ
GT-46400-4024-4.0-T3	20 V	2	40.00	RFQ
GT-46400-4024-3.0-T3	21 V	1.9	39.90	RFQ
GT-46400-4024-2.0-T3	22 V	1.81	39.82	RFQ
GT-46400-4024-1.0-T3	23 V	1.73	39.79	RFQ
GT-46400-4024-T3	24 V	1.66	39.84	RFQ

Model:GT-46400-40VV-X.X-T3

July 24, 2021

SPECIFICATIONS

A) ELECTRICAL SPECIFICATIONS:

01. Input Voltage: Specified 90-264 Vac, Nameplate rated: 100-240Vac
02. Input Frequency: Specified 47-63 Hz, Nameplate rated 50-60Hz
03. Input Rated Current: 1.0A RMS Max
04. Inrush Current: No damage
05. Average Efficiency: 87.6% Min (CEC & DOE LEVEL VI Compliant); 88.3% Min (ErP European Commission's Ecodesign Directive (2005/32/EC) / CoC Tier 2 Compliant)
06. Input Power(no load): <0.1W (CEC & DOE Level VI Compliant); <0.075W ErP European Commission's Ecodesign Directive (2005/32/EC) / CoC Tier 2 Compliant)
07. Load regulation: $\pm 5\%$
08. Ripple Voltage: 120mV (p-p) (100-240V AC Input). Measuring is done by 20MHz bandwidth oscilloscope and terminated each output with a 10uf aluminum electrolytic capacitor and 0.1uf ceramic capacitor.

B) PROTECTION

01. Over-Voltage: Electronically Protected Zener clamp across the output
02. Short Circuit: Electronically Protected unit will auto recover upon removal of fault
03. Over Temperature Protection
04. Over voltage protection: for 12V - 16V; for 15V - 20.25V, for 19V - 25.65, for 24V - 32.4V

C) SAFETY

01. Dielectric Withstand Voltage: 4242Vdc from primary to secondary
02. Earth Leakage Current: <3.5 mA at 240Vac input voltage
03. Touch Current: <0.25mA @ 240Vac input voltage
04. ROHS 2: Complies with EU 2011/65/EU and China SJ/T 11363-2006
05. Earth continuity test:<0.1 Ω or < 0.2 Ω when with SUPPLY CORD"

D) OTHER:

01. MTBF: 200,000 Hours @ 25°C ambient temperature
02. Operating Temperature: 0°C to 40°C ambient temperature
03. Humidity: 10% to 90% relative humidity
04. Storage Temperature: -10°C to 70°C
05. Cooling: Convection
06. ROHS 2: Complies with EU 2011/65/EU and China SJ/T 11363-2006

E) ENCLOSURE

01. Housing: High impact plastic, 94V0 polycarbonate, non-vented
02. Size: 111*52*32.3 +/-1.0 mm
03. Markings: Label and/or Pad Printed and/or Molded in the case

Delivering leading edge, innovative power solutions for more than 30 years....

Model:GT-46400-40VV-X.X-T3

July 24, 2021

DERATING CURVE

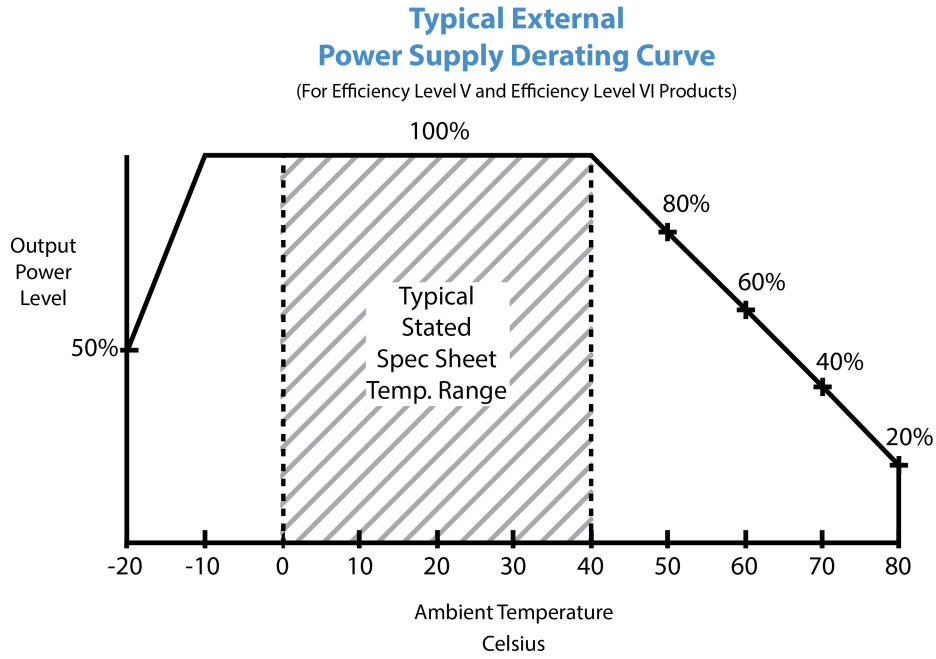

Delivering leading edge, innovative power solutions for more than 30 years...

Model:GT-46400-40VV-X.X-T3

July 24, 2021

INPUT CONFIGURATION

Description IEC 60320/C14 AC Inlet Connector, Class I, Earth Ground

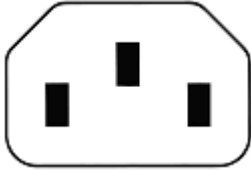

Mates with IEC 60320/C13 Plug

Optional Locking IEC60320 Receptacle and cord option available on some models by request.:

[Standard International IEC 320/C13 Cordsets](#)

Below are standard cordsets which are "not included" (unless stated above); these can be purchased separately or packaged with the power supply. Contact your Sales Engineer if the style required is not shown below. Many more available in different lengths, colors or cable material.

Stock Power Supply Cords

Part Number/ Link	Country	Plug	Termination	Length (mm)	(Ft)
3021457F701(R)	N. American (Type B)	NEMA 5-15P	IEC 320/C13	2150	7
1191068F0701(R)	N. American (Type B)	NEMA 5-15P Hospital	IEC 320/C13	2459	8
2194272M5701-T(R)	Argentina (Type I)	IRAM 2073	IEC 320/C13	2500	8
5502022M5701A(R)	Australian (Type I)	AS3112 / 3 PRONG	IEC 320/C13	2500	8
204B4272M5701(R)	Brazil (Type N)	BRAZIL	IEC 320/C13	2500	8
6023602M5701(R)	China (Type I)	CCC GR2099	IEC 320/C13	2500	8
G8014272M5701(R)	Danish (Type K)	AFSNIT SECTION 107-2-D1	IEC 320/C13	2500	8
23144272M5701-T(R)	Europe (Type E)	CEE 7/7	IEC 320/C13	2500	8
205IN4272M5701(R)	India (Type D)	India IS 1293 (also known as IA16A3 or BS546)	IEC 320/C13	2500	8
208IN4272M5701(R)	India (Type M)	India IS 1293 (also known as IA16A3 or BS546)	IEC320/C13	2500	8
377C4272M5701(R)	Israel (Type H)	ISL 377C	IEC 320/C13	2500	8
23024272M5701(R)	Italy (Type L)	CEI 23-16/VII	IEC 320/C13	2500	8
3003339F701(R) [3x1.25mm2]	Japan (Type B)	JIS 8303 / 3 PINS	IEC 320/C13	2500	8

PROPRIETARY INFORMATION

PROPRIETARY OF GLOBTEK, INC. ANY REPRODUCTION, DISCLOSURE OR USE OF THIS DRAWING, IN WHOLE OR IN PART, IS HEREBY PROHIBITED EXCEPT AS SPECIFIED IN WRITING BY GLOBTEK, INC.

<https://en.globtek.com/datasheet/id/a0Oa000000MikBi>

Delivering leading edge, innovative power solutions for more than **30** years....

Model:GT-46400-40VV-X.X-T3

July 24, 2021

3003068F2701-HK(R) [3 x 2.0mm2]					
302J115J6F0701J(R)	Japan / North America (Type B – 12A)	JIS 8303 / 3 PINS and NEMA 5-15P (PSE and UL/CUL appr)	IEC 320/C13	1830	6
302J104J6F0701J(R)	Japan / North America (Type B – 15A)	JIS 8303 / 3 PINS and NEMA 5-15P (PSE and UL/CUL appr)	IEC 320/C13	1830	6
2313K3432M5701(R)	Korea (Type F)	KS C 8305	IEC 320/C13	2500	8
5804272M5701(R)	Russia (Type F)	GOST 7396	IEC 320/C13	2500	8
2084272M5701(R)	South Africa (Type M)	South Africa SABS164-1 (16A type)	IEC 320/C13	2500	8
23214272M5701(R)	Switzerland (Type J)	SEV 1011	IEC 320/C13	2500	8
3003322M5701(R)	Taiwan (Type B)	BSMI	IEC 320/C13	2500	8
PZ0800100-2M5BK13H(R)	UK, Hong Kong, Singapore, Gulf States (Type G)	BS 1363A	IEC 320/C13	2500	8
7055002M5701A(R)	International	IEC 320 C14-C13	IEC 320/C13	2500	8

Delivering leading edge, innovative power solutions for more than 30 years....

Model:GT-46400-40VV-X.X-T3

July 24, 2021

OUTPUT CONFIGURATION

Common output connector options:

 L Type (Coaxial
5.5x2.5mm plug)

 C Type (Coaxial
5.5x2.1mm plug)

 K Type (Coaxial
3.5x1.3mm plug)

 LL Type (5.5x2.5mm
Locking 760k type)

 CL Type (5.5x2.1mm
Locking S761k type)

 ML2 Type (Molex
housing 43025-0200)

 YL3 Type
(KPPX-3P)

YL4 Type (KPPX-4P)

 EJ1/2/3/4/5 (EIAJ
RC-5320A type
connectors)

 MSB Type (Micro
USB)

 USBC Type (USB
Type C)

 Inquire for custom
design

 For a comprehensive list of options, [click here](#)







Contact GlobTek for your specific requirements or custom solutions.

Delivering leading edge, innovative power solutions for more than 30 years....

Model:GT-46400-40VV-X.X-T3

July 24, 2021









Approvals

Logo	Description
No Logo Applicable	EU 230V CoC Tier 2, 278/2009, Mar 2014
No Logo	IEC 60950-1: 2005 (Second Edition) + Am 1: 2009 + Am 2: 2013
No Logo Applicable	CB for IEC 62368-1:2014 (Second Edition)
	CE Mark: tested to comply with EN55022:2006/A1:2007 Class B, EN610003-2, EN610003-3 including EN61000-4-2, EN61000-4-3, EN61000-4-4, EN61000-4-5, EN61000-4-6N EN61000-4-11; EMI: Complies with EN55011 CLASS B and FCC Part 15B - On label or Molded in case
	CHINA SJ/T 11364-2014, China RoHS Chart: http://en.globtek.com/globtek-rohs.php
Conforms to UL STD. 62368-1 Certified to CSA STD C22.2 NO.62368-1	Conforms to UL STD. 62368-1 Certified to CSA STD C22.2 NO.62368-1
	UL60950-1, cULus to UL 60950-1 E170507
	Declaration ДС № EAЭC N RU Д-US.KA01.B.10453_19 Custom Union of Russia, Belarus and Kazakhstan http://www.globtek.com/redirect/?loc=gost-certificate-eac-declaration
	Compliance of this power supply with FCC Part 15, Class B has been demonstrated with a standard output load. The FCC law stipulates that system-level testing is required to demonstrate compliance with the FCC emission limits with the actual system load.
CAN ICES-3(B)/NMB-3(B)	Compliance of this PSU with Industry Canada, Class B demonstrated with a standard output load. The ICES law stipulates that system-level testing is required to demonstrate compliance with the ICES-3 emission limits with the actual system load.
	Indoor Use Only - Mark is on the label or Molded in the case

Delivering leading edge, innovative power solutions for more than 30 years....

Model:GT-46400-40VV-X.X-T3

July 24, 2021

 GlobTek, Inc.	JAPAN TUV R-PSE, Cert. No. JD 50469658, to J62368-1(H30) , J55032(H29),J3000(H25)[15V or less]. Please reference the following website for guidelines on PSE regulations: http://en.globtek.com/importing-ite-and-medical-power-supplies-ac-adaptors-to-japan/
 GlobTek, Inc.	JAPAN TUV R-PSE, Cert. No. JD 50469658, to J62368-1(H30) , J55032(H29),J3000(H25)[DC15?30V]. Please reference the following website for guidelines on PSE regulations: http://en.globtek.com/importing-ite-and-medical-power-supplies-ac-adaptors-to-japan/
EFFICIENCY LEVEL 	Efficiency: complies to section 301 of Energy Independence and Security Act (EISA) complies with Energy Star tier 2 (North America), ECP tier 2 (China), MEPS tier 2 (Australia), Code of Conduct (Europe)
LPS	Limited Power Source 60950
	Morocco SDoC declaration http://www.globtek.info/certs/Morocco%20SDoC%20Declaration/
RoHS	Specifications of directive 2011/65/EU Annex VI (ROHS-2) with amendment 2015/863-EU (ROHS-3) http://www.ce-mark.com/Rohs%20final.pdf
	SIQ Mark EN 62368-1:2014 + All:2017
	UKCA Certification
 10276	Ukraine UKRSepr (Document: www.globtek.com/html/iso_certificates/GT_Ukraine.pdf)
 LISTED 4MU8 E341351	UL 62368-1 and CAN/CSA C22.2 No. 62368-1-14
	Japan: Voluntary Control Council for Interference (VCCI)

Delivering leading edge, innovative power solutions for more than **30** years....

Model:GT-46400-40VV-X.X-T3

July 24, 2021



WEEE: Complies with EU 2012/19/EU (
http://ec.europa.eu/environment/waste/weee/index_en.htm)
Mark is on the label or Molded in the case