

Delivering leading edge, innovative power solutions for more than **30** years....

Model:GT-46200-20VV-x.x-T3A

July 24, 2021

## GT-46200-20VV-x.x-T3A

### Information

Model Number	GT-46200-20VV-x.x-T3A
Description	Level VI Desktop Power Supply AC Adapter, 20w, output 5-6 VDC

### Model Picture



Agency Documents	<a href="http://www.globtek.info/certs/GT-46200-20VV-X.X-TZ/">http://www.globtek.info/certs/GT-46200-20VV-X.X-TZ/</a>
CE EC-Declaration	<a href="https://www.globtek.com/pdf/ec_declaration/a0Oa000000MFKj1EAH">https://www.globtek.com/pdf/ec_declaration/a0Oa000000MFKj1EAH</a>
RoHS/RoHS2 Declaration	<a href="https://www.globtek.com/pdf/rohs_cert/a0Oa000000MFKj1EAH">https://www.globtek.com/pdf/rohs_cert/a0Oa000000MFKj1EAH</a>
REACH Declaration	<a href="https://www.globtek.com/pdf/iso_certificates/REACH.pdf">https://www.globtek.com/pdf/iso_certificates/REACH.pdf</a>
Conflict Minerals Declaration	<a href="https://www.globtek.com/pdf/conflict-minerals.pdf">https://www.globtek.com/pdf/conflict-minerals.pdf</a>

Delivering leading edge, innovative power solutions for more than **30** years....

Model:GT-46200-20VV-x.x-T3A

July 24, 2021

**MODEL PARAMETERS**

Type	Desktop/External
Technology	Regulated Switchmode AC-DC Power Supply AC Adaptor
Category	ICT/ITE Power Supply
Input Voltage	100-240V~, 50-60 Hz
I/P Amps (A)	0.5 A
Wattage (W)	20.0
Vout Range (V)	5-6
Efficiency Level	USA DOE Level VI / Eco-design Directive 2009/125/EC, (EU) 2019/1782
Ingress Protection	Indoor Use
Size (mm)	80.6*50.0*31.0

Delivering leading edge, innovative power solutions for more than 30 years....

Model:GT-46200-20VV-x.x-T3A

July 24, 2021

ENCLOSURE

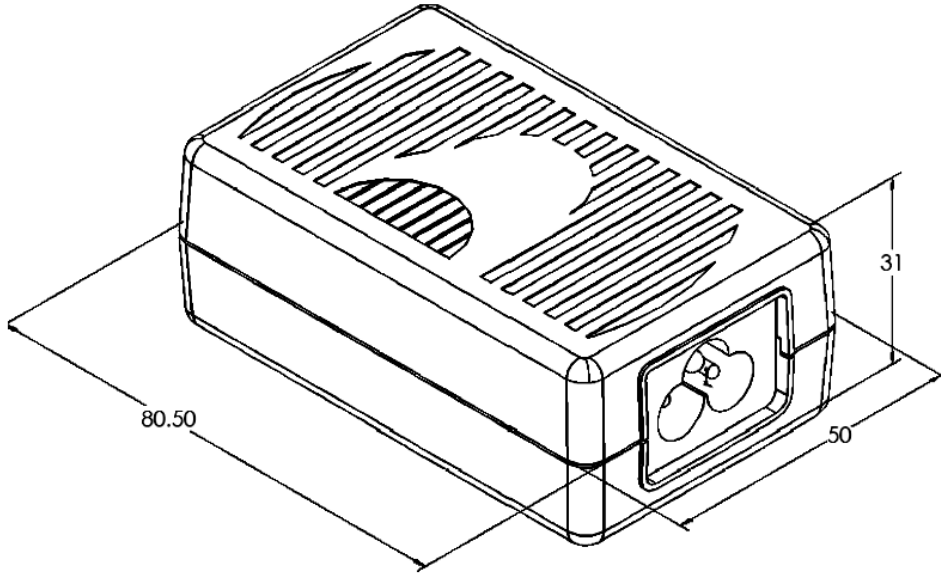

Delivering leading edge, innovative power solutions for more than **30** years....

Model:GT-46200-20VV-x.x-T3A

July 24, 2021

**RATING TABLE**

Model Number	Voltage	Amps(A)	Watts(W)	RFQ
GT-46200-2005-T3A	5 V	4	20.00	<a href="#">RFQ</a>
GT-46200-1806-0.05-T3A	5.95 V	3	17.85	<a href="#">RFQ</a>

## SPECIFICATIONS

### A) ELECTRICAL SPECIFICATIONS:

01. Input Voltage: Specified 90-264 Vac, Nameplate rated: 100-240Vac
  02. Input Frequency: Specified 47-63 Hz, Nameplate rated 50-60Hz
  03. Inrush Current: 50A Max. at 115VAC cold start, 100A Max. at 230VAC cold start
  04. Average Efficiency: 82.44% Min (CEC & DOE LEVEL VI Compliant), 82.97% Min (ErP European Commission's Ecodesign Directive (2005/32/EC) / CoC Tier 2 Compliant)
  05. Input power(no load): <0.1W (CEC & DOE LEVEL VI Compliant), <0.075W (ErP European Commission's Ecodesign Directive (2005/32/EC) / CoC Tier 2 Compliant)
  07. Output Voltage tolerance:  $\pm 5\%$
  08. Load regulation:  $\pm 5\%$
  09. Output Voltage: Tolerance  $\pm 5\%$
  10. Turn On Delay: 3000 mS MAX at 115 VAC Full Load
  11. Hold Up Time: 10 mS Min at 100 VAC Full Load
  12. Ripple Voltage: 150mV (p-p): Input :(100V-240VAC ), Output:full load
- Measuring is done by 20MHz bandwidth oscilloscope and terminated each output with a 10uF aluminum electrolytic capacitor and 0.1uF ceramic capacitor.

### B) PROTECTION

01. Over voltage protection: protection zener
02. Short circuit protection: Output shut down and auto- recover
03. Over Load Protection: Output shut down and auto restart

### C) SAFETY

01. HI-POT : Input to output : 1500VAC or 2121VDC 10mA 1 minute
02. Leakage Current: <0.35mA
03. Earth continuity test:<0.1 Ohm or < 0.2 Ohm when with a non-detachable Power Supply cord, Class I Only
03. Insulation resistance: Input to output: 500vdc to test the input to output resistance not be less 100M ohm

### D) EMC

01. Emissions, per EN 55032, EN 61000-6-3, EN 61000-6-4
  - Conducted Emissions: Class B, FCC Part 15, Class B
  - Radiated Emissions: Class B, FCC Part 15, Class B
02. Line Frequency Harmonics EN61000-3-2, Class A
03. Voltage Fluctuations/Flicker EN61000-3-3
04. Immunity, per EN 55024, EN 61000-6-1, EN 61000-6-2
  - Static Discharge Immunity EN61000-4-2, 4kV Contact Discharge, 8kV air discharge
  - Radiated RF Immunity EN61000-4-3, 3V/m 80-1000MHz, 80% 1KHz AM.
  - EFT/Burst Immunity EN61000-4-4, 1kV/100kHz.
  - Line Surge Immunity EN61000-4-5, 1kV differential, 2kV common-mode
  - Conducted RF Immunity EN61000-4-6, 3Vrms, 80% 1KHz AM
  - Power Frequency Magnetic Field Immunity EN61000-4-8, 1A/m
  - Voltage Dip Immunity EN61000-4-11, Criteria

### E) OTHER:

01. MTBF: 200,000 Hours @ 25°C ambient temperature

## PROPRIETARY INFORMATION

PROPRIETARY OF GLOBTEK, INC. ANY REPRODUCTION, DISCLOSURE OR USE OF THIS DRAWING, IN WHOLE OR IN PART, IS HEREBY PROHIBITED EXCEPT AS SPECIFIED IN WRITING BY GLOBTEK, INC.

<https://en.globtek.com/datasheet/id/a0Oa000000MFKj1>

Delivering leading edge, innovative power solutions for more than **30** years....

Model:GT-46200-20VV-x.x-T3A

July 24, 2021

- 02. Operating Temperature: 0°C to 40°C ambient temperature
- 03. Humidity Operating : 20% to 80%. 0% to 90% relative humidity
- 04. Storage Temperature: -10°C to 70°C  
Humidity Storage: 10% to 90%
- 05. RoHS 2: Complies with EU 2011/65/EU and China SJ/T 11364-2014

**F) ENCLOSURE**

- 01. Housing: High impact plastic, 94V0 polycarbonate, non-vented
- 02. Size: 80.6\*50.0\*31.0 +/-1.0 mm
- 03. Markings: Label and/or Pad Printed and/or Molded in the case

Delivering leading edge, innovative power solutions for more than 30 years....

Model:GT-46200-20VV-x.x-T3A

July 24, 2021

## DERATING CURVE

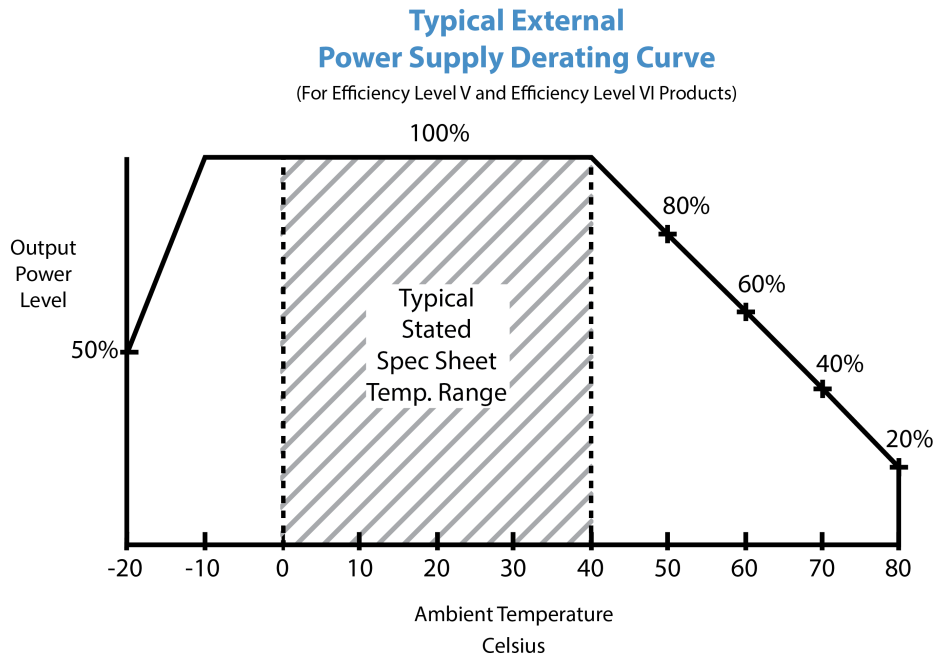

Delivering leading edge, innovative power solutions for more than 30 years....

Model:GT-46200-20VV-x.x-T3A

July 24, 2021

**INPUT CONFIGURATION**

Description IEC 60320/C6 AC Inlet Connector, Class I, Earth Ground ( aka "Mickey Mouse")

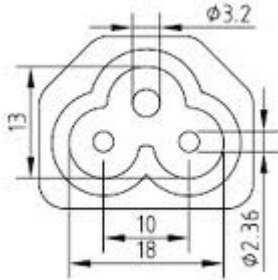

Mates with IEC 60320/C5 Plug

**Standard International IEC 320/C5 Cordsets**

Below are standard cordsets which are "not included" (unless stated above); these can be purchased separately or package with the power supply. Contact your Sales Engineer if the style required is not shown below. Many more available in different lengths, colors or cable material.

Part Number / Link	Country	Plug	Connector	Length (mm)	Length (ft)
<a href="#">3021066F712(R)</a>	N. American (Type B)	NEMA 5-15P	IEC 320/C5	1880	6
<a href="#">1191068F0712(R)</a>	N. American (Type B)	NEMA 5-15P Hospital	IEC 320/C5	2459	8
<a href="#">2194262M0712(R)</a>	Argentina (Type I)	IRAM 2073	IEC320/C5	2050	6.7
<a href="#">2064262M0712(R)</a>	Australian (Type I)	AS3112 / 3 PRONG	IEC 320/C5	2000	6.6
<a href="#">204B4262M0712(R)</a>	Brazil (Type N)	BRAZIL	IEC 320/C5	2000	6.6
<a href="#">6023592M5712(R)</a>	China (Type I)	CCC GR2099	IEC 320/C5	2500	8
<a href="#">23144262M0712(R)</a>	Europe (Type E)	CEE 7/7	IEC 320/C5	2050	6.6
<a href="#">2313K3432M0712(R)</a>	Korea (Type F)	KS C 8305	IEC 320/C5	2000	6.6
<a href="#">205IN4262M0712(R)</a>	India (Type D)	India IS 1293 (also known as IA16A3 or BS546)	IEC320/C5	2000	6.6
<a href="#">377C4262M0712(R)</a>	Israel (Type H)	ISL	IEC320/C5	2050	6.7
<a href="#">23024262M0712(R)</a>	Italy (Type L)	CEI 23-16/VII	IEC 320/C5	2000	6.6
<a href="#">3003316F0712(R)</a>	Japan (Type B)	JIS 8303 / 3 PINS	IEC 320/C5	1830	6
	Japan / USA	JIS 8303 / 3 PINS +			



Delivering leading edge, innovative power solutions for more than **30** years....

Model:GT-46200-20VV-x.x-T3A

July 24, 2021

<a href="#">3021066F0712ULPSE(R)</a> (Type B)	NEMA 5-15P	IEC 320/C5 1830	6
<a href="#">2054262M0712(R)</a>	S. Africa (Type D) South Africa SABS164-1 (6A type plug)	IEC320/C5 2050	6.7
<a href="#">2084262M0712(R)</a>	S.Africa (Type M) South Africa SABS164-1 (16A type plug)	IEC 320/C5 2000	6.6
<a href="#">23214262M0712(R)</a>	Switzerland (Type J) SEV 1011 ( EL 203)	IEC 320/C5 2000	6.6
<a href="#">3003316F0712(R)</a>	Taiwan (Type B) BSMI	IEC 320/C5 2000	6.6
<a href="#">6104262M0712(R)</a>	UK, Hong Kong, Singapore, Gulf States (Type G) BS1363	IEC 320/C5 2000	6.6

Delivering leading edge, innovative power solutions for more than 30 years....

Model:GT-46200-20VV-x.x-T3A

July 24, 2021

**OUTPUT CONFIGURATION**

Common output connector options:

 L Type (Coaxial  
5.5x2.5mm plug)

 C Type (Coaxial  
5.5x2.1mm plug)

 K Type (Coaxial  
3.5x1.3mm plug)

 LL Type (5.5x2.5mm  
Locking 760k type)

 CL Type (5.5x2.1mm  
Locking S761k type)

 ML2 Type (Molex  
housing 43025-0200)

 YL3 Type  
(KPPX-3P)

YL4 Type (KPPX-4P)

 EJ1/2/3/4/5 (EIAJ  
RC-5320A type  
connectors)

 MSB Type (Micro  
USB)

 USBC Type (USB  
Type C)

 Inquire for custom  
design

 For a comprehensive list of options, [click here](#)







Contact GlobTek for your specific requirements or custom solutions.

Delivering leading edge, innovative power solutions for more than 30 years....

Model:GT-46200-20VV-x.x-T3A

July 24, 2021







## Approvals

Logo	Description
No Logo Applicable	EU 230V CoC Tier 2, 278/2009, Mar 2014
No Logo Applicable	CB for IEC 62368-1:2014 (Second Edition) +A11:2017
	CCC to GB4943.1-2011; GB/T9254-2008 GB17625.1-2012, Tropical <2000
	CE Mark: tested to comply with EN55022:2006/A1:2007 Class B, EN610003-2, EN610003-3 including EN61000-4-2, EN61000-4-3, EN61000-4-4, EN61000-4-5, EN61000-4-6N EN61000-4-11; EMI: Complies with EN55011 CLASS B and FCC Part 15B - On label or Molded in case
	CHINA SJ/T 11364-2014, China RoHS Chart: <a href="http://en.globtek.com/globtek-rohs.php">http://en.globtek.com/globtek-rohs.php</a>
Conforms to UL STD. 62368-1 Certified to CSA STD C22.2 NO.62368-1	Conforms to UL STD. 62368-1 Certified to CSA STD C22.2 NO.62368-1
	UL 60950-1, 2nd Edition, 2014-10-14 (Information Technology Equipment - Safety - Part 1: General Requirements) CAN/CSA C22.2 No. 60950-1-07, 2nd Edition, 2014-10 (Information Technology Equipment - Safety - Part 1: General Requirements)
	Declaration ДС № EAЭC N RU Д-US.KA01.B.10453_19 Custom Union of Russia, Belarus and Kazakhstan <a href="http://www.globtek.com/redirect/?loc=gost-certificate-eac-declaration">http://www.globtek.com/redirect/?loc=gost-certificate-eac-declaration</a>
	GOST-R mark for Russia(Document: <a href="http://www.globtek.com/html/iso_certificates/GT_GOST-R.pdf">http://www.globtek.com/html/iso_certificates/GT_GOST-R.pdf</a> ). 03/15/2015. Due to lack of demand, GlobTek will not be renewing it's GOST certification. Please contact your sales engineer for pricing on EAC.
	Indoor Use Only - Mark is on the label or Molded in the case
	Ingress Protection: ?IP40 to IEC60529:2001 Protection against

Delivering leading edge, innovative power solutions for more than 30 years....

Model:GT-46200-20VV-x.x-T3A



July 24, 2021

IP40	granular foreign bodies (with I/P cord)
 GlobTek, Inc.	JAPAN TUV R-PSE, Cert. No. JD 50471561, to J62368-1(H30) , J55032(H29), J3000(H25) ,[15V or less]. Please reference the following website for PSE regulations: <a href="http://en.globtek.com/importing-ite-and-medical-power-supplies-ac-adaptors-to-japan/">http://en.globtek.com/importing-ite-and-medical-power-supplies-ac-adaptors-to-japan/</a>
EFFICIENCY LEVEL 	Efficiency: complies to section 301 of Energy Independence and Security Act (EISA) complies with Energy Star tier 2 (North America), ECP tier 2 (China), MEPS tier 2 (Australia), Code of Conduct (Europe)
LPS	Limited Power Source 60950
	Morocco SDoC declaration <a href="http://www.globtek.info/certs/Morocco%20SDoC%20Declaration/">http://www.globtek.info/certs/Morocco%20SDoC%20Declaration/</a>
 N136 SAA-160906-EA	RCM certificate SAA-160906-EA; Australia and New Zealand Regulatory Compliance, Mark ( <a href="http://rcm.standards.org.au/rcmfaq/rcmfaq.htm">http://rcm.standards.org.au/rcmfaq/rcmfaq.htm</a> )
RoHS	Specifications of directive 2011/65/EU Annex VI (ROHS-2) with amendment 2015/863-EU (ROHS-3) <a href="http://www.ce-mark.com/Rohs%20final.pdf">http://www.ce-mark.com/Rohs%20final.pdf</a>
	RCM certificate SAA-210574-EA; Australia and New Zealand Regulatory Compliance, Mark ( <a href="http://rcm.standards.org.au/rcmfaq/rcmfaq.htm">http://rcm.standards.org.au/rcmfaq/rcmfaq.htm</a> )
	SIQ Mark EN 62368-1:2014 + All:2017
	UKCA Certification
 10276	Ukraine UKRSepr (Document: <a href="http://www.globtek.com/html/iso_certificates/GT_Ukraine.pdf">www.globtek.com/html/iso_certificates/GT_Ukraine.pdf</a> )

Delivering leading edge, innovative power solutions for more than **30** years....

Model:GT-46200-20VV-x.x-T3A

July 24, 2021

	UL 62368-1 and CAN/CSA C22.2 No. 62368-1-14
	Japan: Voluntary Control Council for Interference (VCCI)
	WEEE: Complies with EU 2012/19/EU ( <a href="http://ec.europa.eu/environment/waste/weee/index_en.htm">http://ec.europa.eu/environment/waste/weee/index_en.htm</a> ) Mark is on the label or Molded in the case