

Delivering leading edge, innovative power solutions for more than 30 years....

Model:GTM41080-18VV-F

July 24, 2021

GTM41080-18VV-F

Information

Model Number

GTM41080-18VV-F

Description

GTM41080-18VV-F, ICT / ITE / Medical Power Supply, 60601-1-4th Ed. , Open Frame/Internal, Regulated Switchmode AC-DC Power Supply AC Adaptor, , Input Rating: 100-240V~, 50-60 Hz, Molex 09-65-2038 3 Position Header Pin 1: Neutral, Pin 2: Removed, Pin 3: Line, Output Rating: 18 Watts, Power rating with convection cooling (W) , 5-48 (Class II)V in 0.1V increments, Approvals: Fuse 60335; CB EN/IEC 60335-1; cETLus 60601-1 3rd; CB 60601-1 2MOPP; CE; cETLus ES60601; China RoHS; Fuse 60335; Level V; NEMKO EN/IEC 60335-1; RoHS; S-Mark IEC/EN 60601-1; WEEE; CB EN/IEC 60335-1; Class I; EAC; NOM; CE; CB 60601-1; CE; Double Insulation;

Model Picture



Agency Documents

<http://www.globtek.info/certs/GTM41080/>

CE EC-Declaration

https://www.globtek.com/pdf/ec_declaration/a0Oa000000J9g4DEAR

RoHS/RoHS2 Declaration

https://www.globtek.com/pdf/rohs_cert/a0Oa000000J9g4DEAR

REACH Declaration

https://www.globtek.com/pdf/iso_certificates/REACH.pdf

Conflict Minerals Declaration

<https://www.globtek.com/pdf/conflict-minerals.pdf>

Delivering leading edge, innovative power solutions for more than **30** years....

Model:GTM41080-18VV-F

July 24, 2021

MODEL PARAMETERS

| | |
|--------------------|--|
| Type | Open Frame/Internal |
| Technology | Regulated Switchmode AC-DC Power Supply AC Adaptor |
| Category | ICT / ITE / Medical Power Supply |
| Input Voltage | 100-240V~, 50-60 Hz |
| I/P Amps (A) | 0.6A |
| Wattage (W) | 18.0 |
| Vout Range (V) | 5-48 (Class II) |
| Efficiency Level | V |
| Ingress Protection | IPX0 |
| Size (mm) | 74*44*34 |

Delivering leading edge, innovative power solutions for more than 30 years....

Model:GTM41080-18VV-F

July 24, 2021

ENCLOSURE

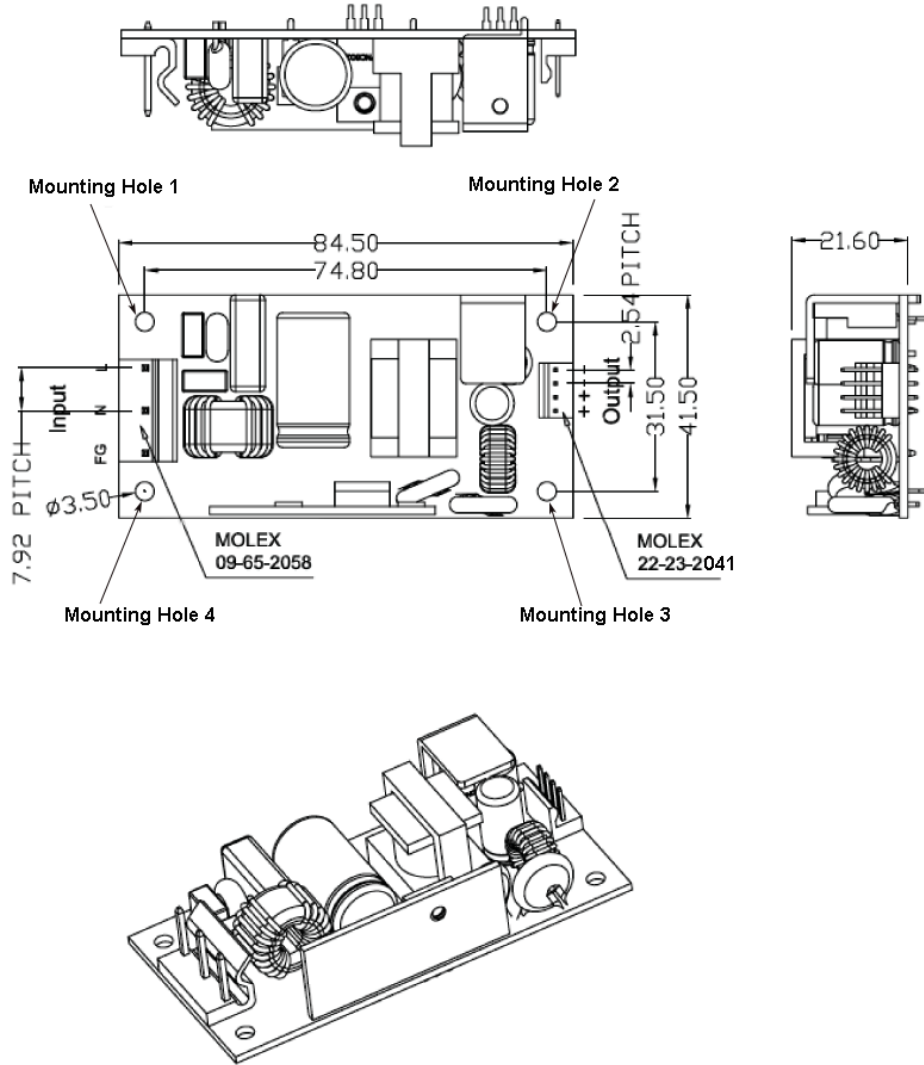

Delivering leading edge, innovative power solutions for more than **30** years....

Model:GTM41080-18VV-F

July 24, 2021

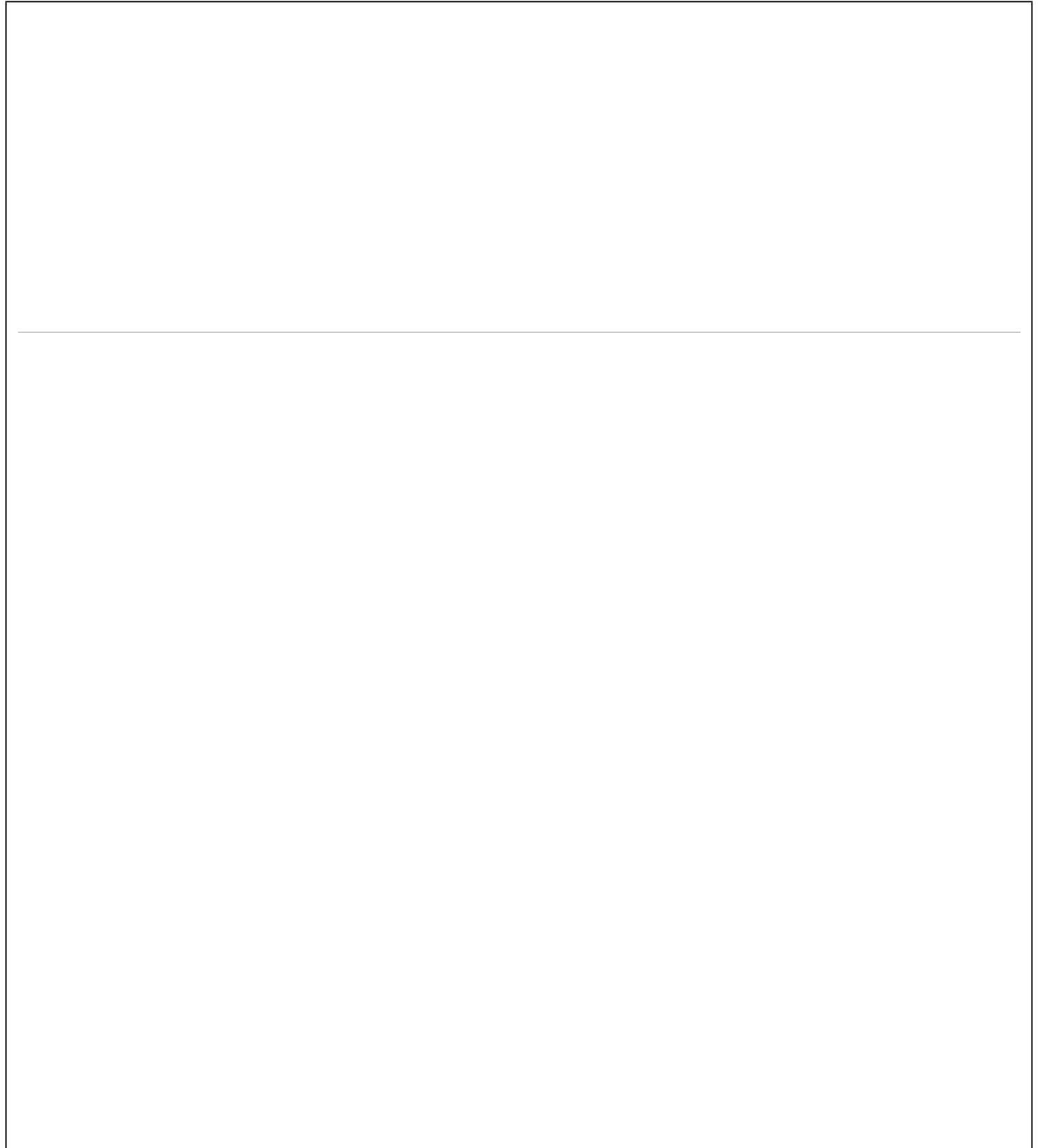

PROPRIETARY INFORMATION

PROPRIETARY OF GLOBTEK, INC. ANY REPRODUCTION, DISCLOSURE OR USE OF THIS DRAWING, IN WHOLE OR IN PART, IS HEREBY PROHIBITED EXCEPT AS SPECIFIED IN WRITING BY GLOBTEK, INC.

<https://en.globtek.com/datasheet/id/a0Oa000000J9g4D>

Delivering leading edge, innovative power solutions for more than **30** years....

Model:GTM41080-18VV-F

July 24, 2021

RATING TABLE

| Model Number | Voltage | Amps(A) | Watts(W) | RFQ |
|---------------------------------|---------|---------|----------|---------------------|
| a17a000000LICsk | V | | | RFQ |
| GTM41080-1507-2.0-F | 5 V | 3.6 | 18.00 | RFQ |
| GTM41080-1507-1.0-F | 6 V | 2.5 | 15.00 | RFQ |
| GTM41080-1507-F(Class II) | 7 V | 2.14 | 14.98 | RFQ |
| GTM41080-1511-3.5-F(Class II) | 7.5 V | 2 | 15.00 | RFQ |
| GTM41080-1811-2.0-F(Class II) | 9 V | 2 | 18.00 | RFQ |
| GTM41080-1811-1.0-F(Class II) | 10 V | 1.8 | 18.00 | RFQ |
| GTM41080-1817.9-5.9-F(Class II) | 12 V | 1.5 | 18.00 | RFQ |
| GTM41080-1817.9-2.9-F(Class II) | 15 V | 1.2 | 18.00 | RFQ |
| GTM41080-1830-12.0-F(Class II) | 18 V | 1 | 18.00 | RFQ |
| GTM41080-1830-11.0-F(Class II) | 19 V | 0.94 | 17.86 | RFQ |
| GTM41080-1830-10.0-F(Class II) | 20 V | 0.9 | 18.00 | RFQ |
| GTM41080-1830-6.0-F | 24 V | 0.75 | 18.00 | RFQ |
| GTM41080-1830-F(Class II) | 30 V | 0.6 | 18.00 | RFQ |
| GTM41080-1848-12.0-F(Class II) | 36 V | 0.5 | 18.00 | RFQ |
| GTM41080-1848-8.0-F(Class II) | 40 V | 0.45 | 18.00 | RFQ |
| GTM41080-1848-F(Class II) | 48 V | 0.375 | 18.00 | RFQ |

Model:GTM41080-18VV-F

July 24, 2021

SPECIFICATIONS

A) ELECTRICAL SPECIFICATIONS:

01. Input Voltage: 100-240 Vac
02. Input Frequency: 47 - 63 Hz
03. Output Regulation: +/- 5% measured at the output connector
04. Line Voltage Regulation: +/- 1% typical measured at full load
05. Output Ripple (Vp-p): +/-1% or 150 mV whichever is greater, measured at 20 MHz bandwidth with 0.1 uf ceramic capacitor in parallel with 10 uf electrolytic capacitor connected at the end of the output connector at nominal line
06. Turn-ON/OFF Overshoot: 5% maximum, 1 mS typical recovery time for 25% to 50% step load
07. Turn-ON Delay: 3000 mS, maximum @ full load, nominal line
08. Hold-Up Time: 8 mS typical @ nominal input voltage and full load
09. Inrush Current: 30A maximum cold start @ 240Vac input
10. Switching Frequency: 65 KHz typical
11. Efficiency: Compliant with Worldwide Level V standards.
12. No Load Standby Power: <0.3 W

B) PROTECTION

01. Over-Voltage: Electronically Protected Zener clamp across the output
02. Short Circuit: Electronically Protected unit will auto recover upon removal of fault
04. Input Protection: Input line and neutral fusing

C) SAFETY

01. Protection class: Factory configured and labeled as Class I Functional Earth equipment. May be used as Class II equipment by physically removing(cutting) the Functional Earth terminal from the input connector (as provisioned by CB report). May be ordered as Class II with a 2 circuit input connector and double-box marking under an alternate ordering part number.
02. Dielectric Withstand Voltage: 5656Vdc from primary to secondary
03. Earth Leakage Current: <0.25 mA at 240Vac input voltage

D) OTHER:

01. MTBF: 200,000 Hours @ 25°C ambient temperature
02. Operating Temperature: 0°C to 40°C ambient temperature
03. Humidity: 0% to 90% relative humidity
04. Storage Temperature: -10°C to 80°C
05. Cooling: Convection

E) ENCLOSURE

01. Open Frame
02. Size: 84.5*41.5*21.6 mm +/-1.0 mm (3.3*1.6*0.9 inches)
03. Markings: Label

Delivering leading edge, innovative power solutions for more than **30** years....

Model:GTM41080-18VV-F

July 24, 2021

DERATING CURVE

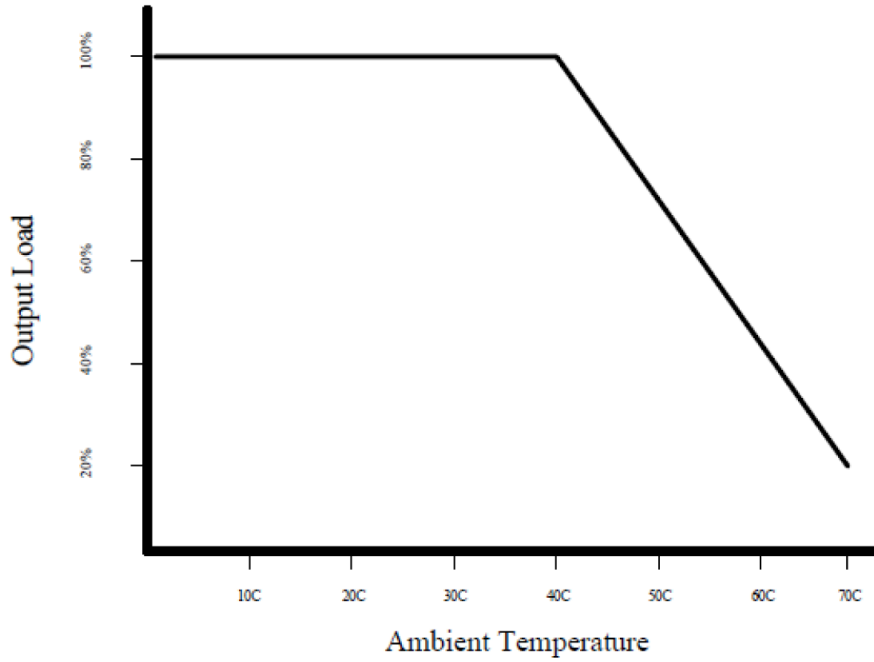

Delivering leading edge, innovative power solutions for more than **30** years....

Model:GTM41080-18VV-F

July 24, 2021

INPUT CONFIGURATION

 Description Molex 09-65-2038 3 Position Header Pin 1: Neutral, Pin 2: Removed, Pin 3: Line

 Document: http://www.molex.com/pdm_docs/sd/009652038_sd.pdf

 Catalog Page: http://www.molex.com/molex/products/datasheet.jsp?part=active/0009652038_PCB_HEADERS.xml

Mates With Part(s):
[5195](#) SPOX™ Crimp Housing, [5239](#) KK® Crimp Housing



Optional Input Wiring Kits are available:

| PN/Ordering No | Length | End A | End B |
|------------------------------------|--------|--------------|------------------|
| XHP410070M7MLX3(R) | 70 | JST XHP-4 | Molex 09-93-0300 |
| C810070M6MLX3(R) | 60 | IEC60320 C8 | Molex 09-93-0300 |
| C1410070M6MLX3(R) | 60 | IEC60320 C14 | Molex 09-93-0300 |

Model:GTM41080-18VV-F

July 24, 2021











Approvals

| Logo | Description |
|---|---|
|  | Book 60335 up to 36 Volts |
|  | Book 60335 up to 36 Volts |
| No Logo Applicable | CB to IEC 60601-1:2005 (Third Edition) + CORR. 1:2006 + CORR. 2:2007 + A1:2012 (or IEC 60601-1: 2012 reprint) |
| No Logo Applicable | CB to IEC 60601-1:2005 (Third Edition) + CORR. 1:2006 + CORR. 2:2007 + A1:2012 (or IEC 60601-1: 2012 reprint) |
| No Logo Applicable | CB report IEC 60601-1: 2005 + CORR. 1 (2006) + CORR. 2 (2007) and or EN 60601-1:2006 3rd Edition 2xMOPP |
| No Logo Applicable | CB to 60335-1:2010 (Fifth Edition) incl. Corr. 1:2010 and Corr. 2:2011 + A1:2013 |
| No Logo Applicable | CB to 60335-1:2010 (Fifth Edition) incl. Corr. 1:2010 and Corr. 2:2011 + A1:2013 |
| No Logo Applicable | CB to 60335-1 5th Edition (Safety of Household and Similar Electrical Appliances, Part 1: General Requirements) CB Report/ Certificate IEC 60335-1:2010 Up to 36 volts only |
| No Logo Applicable | CB to 60335-1 5th Edition (Safety of Household and Similar Electrical Appliances, Part 1: General Requirements) CB Report/ Certificate IEC 60335-1:2010 Up to 36 volts only |
| No Logo Applicable | CB to 60601-1 3rd Edition 2xMOPP, CB Certificate: IEC 60601-1:2005, CB report: IEC 60601-1: 2005 + CORR. 1 (2006) + CORR. 2 (2007) and EN 60601-1:2006 |
|  | CE Certification CE Mark: tested to comply with EN 55032.2012+AC.2013 EN 61000-3-2.2014 EN 61000-3-3.2013 EN 60601-1-2.2015 EN 55024.2010 |
| | CE Certification |

Delivering leading edge, innovative power solutions for more than 30 years....

Model:GTM41080-18VV-F











July 24, 2021

| | |
|---|---|
|  | CE Mark: tested to comply with EN 55032.2012+AC.2013 EN 61000-3-2.2014 EN 61000-3-3.2013 EN 60601-1-2.2015 EN 55024.2010 |
|  | CE Mark: tested to comply with EN 60601-1-2:2015 Medical electrical equipment Part 1-2: - Mark is on the label or Molded in the case |
|  | CE Mark: tested to comply with EN 60601-1-2:2015 Medical electrical equipment Part 1-2: - Mark is on the label or Molded in the case |
|  | CE Mark: tested to comply with EN 60601-1-2:2015 Medical electrical equipment Part 1-2: - Mark is on the label or Molded in the case |
|  | CE Mark: tested to comply with EN 60601-1-2:2015 Medical electrical equipment Part 1-2: - Mark is on the label or Molded in the case |
| Conforms to ANSI/AAMI ES 60601-1:2005 Cert.to CAN/CSA Std. C22.2 | cETLus ANSI_AAMI ES60601-1_2005 |
| Conforms to ANSI/AAMI ES 60601-1:2005 Cert.to CAN/CSA Std. C22.2 | cETLus ANSI_AAMI ES60601-1_2005 |
|  | cETLus-Cert-4007497 ANSI/AAMI ES60601-1:2005 with AMD C1: 2009, AMD C2: 2010 and CAN/CSA-C22.2 No. 60601-1 2008 with COR 2:2011+ANSI/AAMI HA60601-1-11 Ed:1 |
|  | cETLus-Cert-4007497 ANSI/AAMI ES60601-1:2005 with AMD C1: 2009, AMD C2: 2010 and CAN/CSA-C22.2 No. 60601-1 2008 with COR 2:2011+ANSI/AAMI HA60601-1-11 Ed:1 |
|  | CHINA SJ/T 11364-2014, China RoHS Chart: http://en.globtek.com/globtek-rohs.php |
|  | CHINA SJ/T 11364-2014, China RoHS Chart: http://en.globtek.com/globtek-rohs.php |
| | Class I Earth Ground |
|  | |

Delivering leading edge, innovative power solutions for more than 30 years....

Model:GTM41080-18VV-F

July 24, 2021

| | |
|---|--|
|  | Certification # TC RU AR46.B.75423 Custom Union of Russia, Belarus and Kazakhstan |
| T1.6A 250VAC  | Fuse 60335 T1.6A 250VAC Up to 36 volts |
| T1.6A 250VAC  | Fuse 60335 T1.6A 250VAC Up to 36 volts |
|  | Indoor Use Only - Mark is on the label or Molded in the case |
|  | Indoor Use Only - Mark is on the label or Molded in the case |
| EFFICIENCY LEVEL  | Efficiency: complies to section 301 of Energy Independence and Security Act (EISA) complies with Energy Star tier 2 (North America), ECP tier 2 (China), MEPS tier 2 (Australia), Code of Conduct (Europe) |
| EFFICIENCY LEVEL  | Efficiency: complies to section 301 of Energy Independence and Security Act (EISA) complies with Energy Star tier 2 (North America), ECP tier 2 (China), MEPS tier 2 (Australia), Code of Conduct (Europe) |
|  IEC/EN60335-1 | NEMKO IEC/EN 60335-1 (Safety of Household and Similar Electrical Appliances, Part 1: General Requirements) up to 36 Volts |
|  IEC/EN60335-1 | NEMKO IEC/EN 60335-1 (Safety of Household and Similar Electrical Appliances, Part 1: General Requirements) up to 36 Volts |
|  Fuente de alimentación | NOM (Mexico) to NOM-001-SCFI-1993 GTM41080-1507-2.0 5V only |
| RoHS | Specifications of directive 2011/65/EU Annex VI (ROHS-2) with amendment 2015/863-EU (ROHS-3) http://www.ce-mark.com/Rohs%20final.pdf |
| RoHS | Specifications of directive 2011/65/EU Annex VI (ROHS-2) with amendment 2015/863-EU (ROHS-3) http://www.ce-mark.com/Rohs%20final.pdf |
| | |

Delivering leading edge, innovative power solutions for more than **30** years....

Model:GTM41080-18VV-F

July 24, 2021

| | |
|--|---|
|  Intertek IEC/EN60601-1 | Semko S-Mark-Cert-EN60601-1 3.1rd Edition (http://www.intertek.com/marks/s/) |
|  Intertek IEC/EN60601-1 | Semko S-Mark-Cert-EN60601-1 3.1rd Edition (http://www.intertek.com/marks/s/) |
|  | UKCA Certification |
|  | UKCA Certification |
|  | WEEE: Complies with EU 2012/19/EU (http://ec.europa.eu/environment/waste/weee/index_en.htm) Mark is on the label or Molded in the case |
|  | WEEE: Complies with EU 2012/19/EU (http://ec.europa.eu/environment/waste/weee/index_en.htm) Mark is on the label or Molded in the case |