

Delivering leading edge, innovative power solutions for more than **30** years....

Model:GTM96300-36VV-P2

July 24, 2021

GTM96300-36VV-P2

Information

Model Number	GTM96300-36VV-P2
Description	GTM96300-36VV-P2, Medical/ICT/ITE/Household use Power Supply, 60601-1-4th Ed. , Desktop/External, Regulated Switchmode AC-DC Power Supply AC Adaptor, , Input Rating: 100-240V~, 50-60 Hz, Input Wires 2x 305mm stranded UL1015 or equivalent, White=Neutral and Black=Line, Output Rating: 36 Watts, Power rating with convection cooling (W) , 5-54V in 0.1V increments, Approvals: Double Insulation; 230V CoC Tier 2; CB 60601-1; CB 60950; CE; CE; China RoHS; EAC; ETL; CAN ICES-3; PSE; PSE; PSE; Level VI; LPS; RoHS; S-Mark IEC/EN 60601-1; S-Mark 60950; Ukraine; VCCI; WEEE;
Model Picture	
Agency Documents	http://www.globtek.info/certs/GTM96300-TZ/
CE EC-Declaration	https://www.globtek.com/pdf/ec_declaration/a0O3a00000LvrU1EAJ
RoHS/RoHS2 Declaration	https://www.globtek.com/pdf/rohs_cert/a0O3a00000LvrU1EAJ
REACH Declaration	https://www.globtek.com/pdf/iso_certificates/REACH.pdf
Conflict Minerals Declaration	https://www.globtek.com/pdf/conflict-minerals.pdf

Delivering leading edge, innovative power solutions for more than **30** years....

Model:GTM96300-36VV-P2

July 24, 2021

MODEL PARAMETERS

Type	Desktop/External
Technology	Regulated Switchmode AC-DC Power Supply AC Adaptor
Category	Medical/ICT/ITE/Household use Power Supply
Input Voltage	100-240V~, 50-60 Hz
I/P Amps (A)	1A
Wattage (W)	36.0
Vout Range (V)	5-54
Efficiency Level	USA DOE Level VI / Eco-design Directive 2009/125/EC, (EU) 2019/1782
Ingress Protection	IP68
Size (mm)	102*46*37

Delivering leading edge, innovative power solutions for more than 30 years....

Model:GTM96300-36VV-P2

July 24, 2021

ENCLOSURE

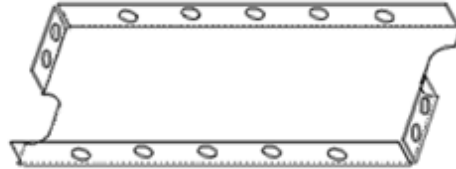
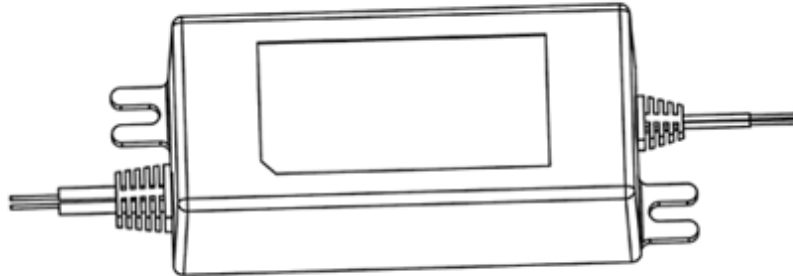
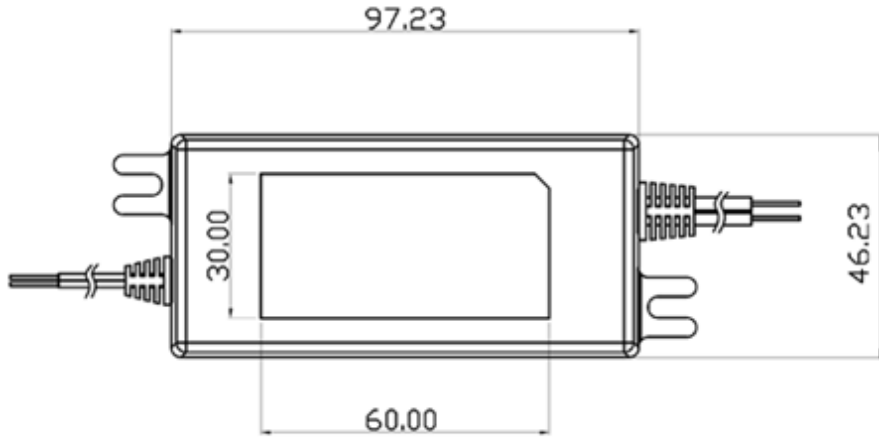

Delivering leading edge, innovative power solutions for more than **30** years....

Model:GTM96300-36VV-P2

July 24, 2021

RATING TABLE

Model Number	Voltage	Amps(A)	Watts(W)	RFQ
GTM96300-2307.5-2.5-P2	5 V	4.5	22.50	RFQ

Model:GTM96300-36VV-P2

July 24, 2021

SPECIFICATIONS

A) ELECTRICAL SPECIFICATIONS:

01. Input Voltage: Specified 90-264 Vac, Nameplate rated: 100-240Vac
 - 90-264 Vac range @ 100% of rated load current
 - 85-264 Vac range @ 85% of rated load current
 - 110-370 VDC range @ 100% of rated load current
02. Input Frequency: Specified 47-63 Hz, Nameplate rated 50-60Hz
03. Output Regulation: +/- 5% measured at the output connector
04. Line Voltage Regulation: +/- 0.5% typical measured at full load
05. Green Power On Indicator LED
06. Output Ripple (Vp-p): 1% or 100 mV whichever is greater, measured at 20 MHz bandwidth with 0.1 uf ceramic capacitor in parallel with a low impedance 47 uf electrolytic capacitor connected at the end of the output connector
07. Turn-ON/OFF Overshoot: 5% maximum, 1 mS typical recovery time for 40% to 70% step load
08. Turn-ON Delay: 1 second maximum @ full load, nominal line
09. Hold-Up Time: 8 mS typical @ nominal input voltage and full load
10. Inrush Current: 30A/60A maximum cold start @ 115/230Vac input
11. Efficiency: Compliant with Efficiency Level VI and CoC Tier 2 standards
12. No Load Standby Power: <0.075 W @ 230Vac

B) PROTECTION

01. Input Protection: Input line fusing and 300Vac MOV
02. Short Circuit/ Overload: Electronically Protected unit will auto recover upon removal of fault
 - Output Current Limit: 110% to 160% of rated output current
(upper end of current limit range is determined by normal output power rating, not derated output power level)
03. Output Over-Voltage: 110% to 130% of nominal output voltage

C) SAFETY

01. Dielectric Withstand Voltage: 4000Vac or 5656Vdc from input to output, On Class I models, 3000Vac or 4242Vdc from input to earth
02. Earth Leakage Current: Class I models < 300uA, N/A for Class II models
03. Touch Current: Class I models < 20uA, Class II models < 75uA
04. Earth Continuity Test: < 0.1 Ohm between Earth Pin at AC input and PCB termination point (Class I models only)
05. Means of Protection: 2 x MOPP
06. Compliant Standards: See listings at end of this drawing for specifics
07. Output Isolation Options:
 - a) C8 or C18 Inlet, Class II
 - b) C6 or C14 Inlet, Class II FE, Output Isolated from Earth contact
 - c) C6 or C14 Inlet, Class I, Output negative directly attached to Earth contact

D) EMC

- EN 60601-1-2, 4th edition
Emissions, per EN 55032, EN 61000-6-3, EN 61000-6-4, CISPR11 and CISPR22
Conducted Emissions: Class B, FCC Part 15, Class B
Radiated Emissions: Class B, FCC Part 15, Class B

PROPRIETARY INFORMATION

PROPRIETARY OF GLOBTEK, INC. ANY REPRODUCTION, DISCLOSURE OR USE OF THIS DRAWING, IN WHOLE OR IN PART, IS HEREBY PROHIBITED EXCEPT AS SPECIFIED IN WRITING BY GLOBTEK, INC.

<https://en.globtek.com/datasheet/id/a003a00000LvrU1>

Delivering leading edge, innovative power solutions for more than 30 years....

Model:GTM96300-36VV-P2

July 24, 2021

Line Frequency Harmonics EN61000-3-2, Class A
Voltage Fluctuations/Flicker EN61000-3-3

Immunity, per EN 55024, EN 61000-6-1, EN 61000-6-2
Static Discharge Immunity EN61000-4-2, 10kV Contact Discharge, 20kV air discharge
Radiated RF Immunity EN61000-4-3, 10V/m 80-1000MHz, 3V/m 1-2.7GHz, 80% 1KHz AM.
EFT/Burst Immunity EN61000-4-4, 4kV/100kHz.
Line Surge Immunity EN61000-4-5, 2kV differential, 4kV common-mode
Conducted RF Immunity EN61000-4-6, 3Vrms, 80% 1KHz AM
Power Frequency Magnetic Field Immunity EN61000-4-8, 3A/m
Voltage Dip Immunity EN61000-4-11, Performance Criteria B/C

E) OTHER:

01. MTBF: 1,000,000 Hours @ 40°C ambient temperature, Full Load
02. GTM96300 Family: -10°C to 40°C ambient temperature with full load
Regarding Operating Temperature,
 - a- See below derating table for output power capability at alternate temperature
 - b- Extended low end temperature range available as custom option
03. Operating Humidity: 0% to 95% relative humidity, non-condensing
04. Storage Temperature: -30°C to 80°C
05. Operating Altitude: 5000 Meters
06. ROHS: Compliant with latest regulations, see approvals section below

F) ENCLOSURE

01. Housing: High impact plastic, 94V0 polycarbonate, non-vented
02. Markings: Label or Laser Printed
03. AC Input mechanical options: Desktop C6, C8, C14 or C18 IEC Inlet.
Hybrid option (Desktop or Changeable Blade Wall Plug-in) Class I or Class II input

G) SPECIAL OPTIONS

01. Cost reduction, removal of LED
02. Custom Cordsets, various cordage types, and connector types
03. Custom Markings
04. Short term Output Surge Capability
05. Reduced Leakage Current versions
06. Tightened output voltage tolerance
07. Reduced output ripple level
08. Reduced output power rating marking
09. High Rel PCB laminate with Plated through Holes for IPC610 Class 2 Compliance
10. Special Housing Colors and Cordset Colors
11. Quasi Constant Current Output, for Battery Charger Applications
12. Back EMF applications, custom solutions. For unusual motor load aps and other high inductance reverse energy flow requirements
13. Improved Ingress Protection Rating

Delivering leading edge, innovative power solutions for more than 30 years....

Model:GTM96300-36VV-P2

July 24, 2021

DERATING CURVE

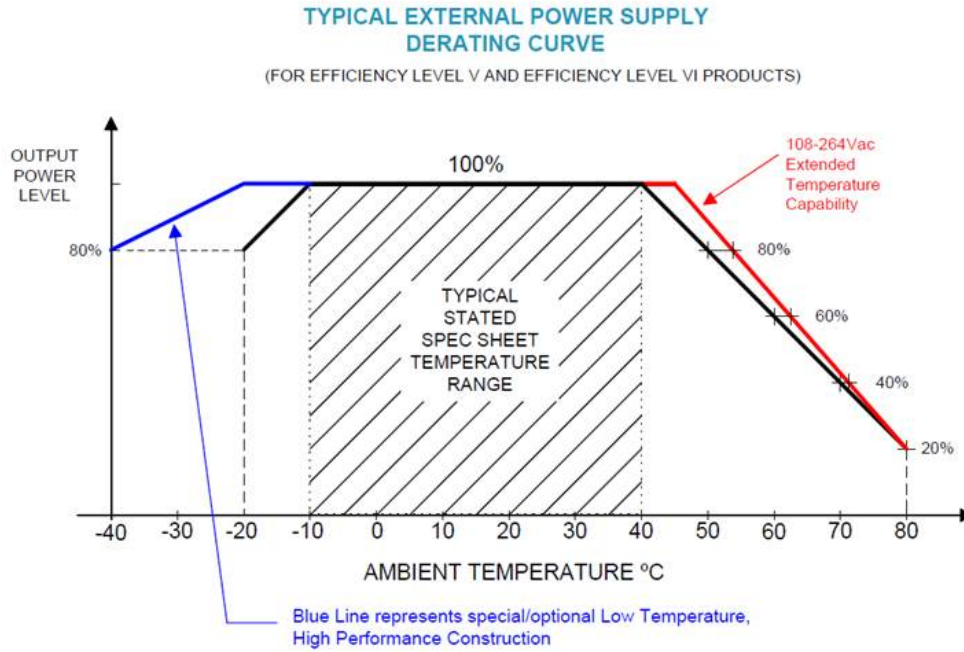

Delivering leading edge, innovative power solutions for more than 30 years....

Model:GTM96300-36VV-P2

July 24, 2021

INPUT CONFIGURATION

Description Input Wires 2x 305mm stranded UL1015 or equivalent, White=Neutral and Black=Line

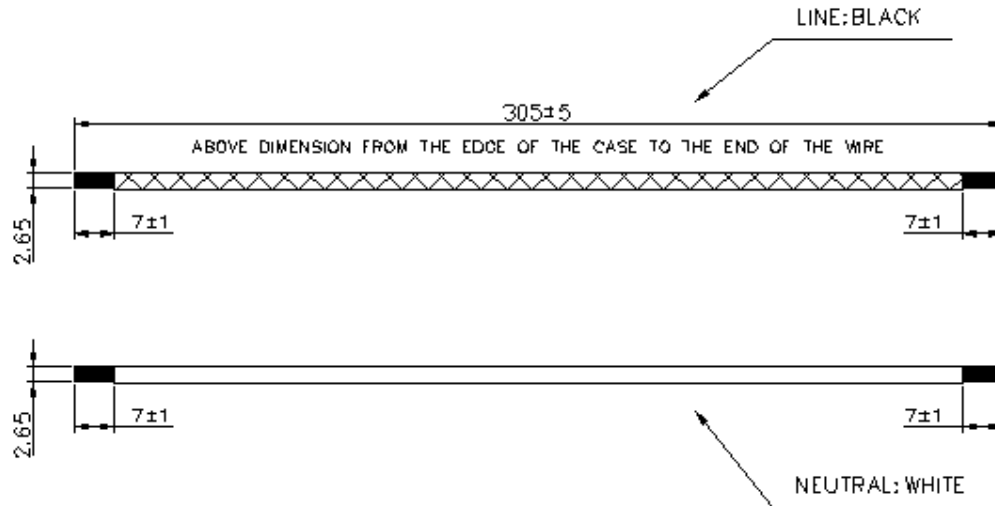

Wire gauge (AWG): 18 AWG

Delivering leading edge, innovative power solutions for more than 30 years....

Model:GTM96300-36VV-P2

July 24, 2021

OUTPUT CONFIGURATION

Common output connector options:

 L Type (Coaxial
5.5x2.5mm plug)

 C Type (Coaxial
5.5x2.1mm plug)

 K Type (Coaxial
3.5x1.3mm plug)

 LL Type (5.5x2.5mm
Locking 760k type)

 CL Type (5.5x2.1mm
Locking S761k type)

 ML2 Type (Molex
housing 43025-0200)

 YL3 Type
(KPPX-3P)

YL4 Type (KPPX-4P)

 EJ1/2/3/4/5 (EIAJ
RC-5320A type
connectors)

 MSB Type (Micro
USB)

 USBC Type (USB
Type C)

 Inquire for custom
design

 For a comprehensive list of options, [click here](#)

Contact GlobTek for your specific requirements or custom solutions.

Delivering leading edge, innovative power solutions for more than 30 years....

Model:GTM96300-36VV-P2

July 24, 2021









Approvals

Logo	Description
No Logo Applicable	EU 230V CoC Tier 2, 278/2009, Mar 2014
No Logo Applicable	CB for IEC 60601-1:2005 (Third Edition) + CORR. 1 (2006) + CORR. 2 (2007) + AM1 (2012) or IEC 60601-1 (2012 reprint) (Ed 3.1) up to 48V only
No Logo Applicable	CB for IEC 60950-1:2005 (Second Edition) + Am 1:2009 + Am 2:2013
	CE Mark: tested to comply with EN 55032:2012+AC:2013, EN 61000-3-2:2014, EN 61000-3-3:2013, EN 55024:2010, EN 60601-1-2:2015
	CE Certification CE Mark: tested to comply with EN 55032.2012+AC.2013 EN 61000-3-2.2014 EN 61000-3-3.2013 EN 60601-1-2.2015 EN 55024.2010
	CHINA SJ/T 11364-2014, China RoHS Chart: http://en.globtek.com/globtek-rohs.php
Conforms to UL STD. 62368-1 Certified to CSA STD C22.2 NO.62368-1	Conforms to UL STD. 62368-1 Certified to CSA STD C22.2 NO.62368-1
	
	Declaration ДС № EAЭC N RU Д-US.KA01.B.10453_19 Custom Union of Russia, Belarus and Kazakhstan http://www.globtek.com/redirect/?loc=gost-certificate-eac-declaration
	IEC 60601-1-11 Issued: 2015/01/20 Ed. 2 Medical Elec. Equip.- Part 1-11: Gen. Req. for Basic Safety & Essential Perf.- Collateral Standard - Req. for Medical Elec. Equip. & Medical Elec.Systems Used in the Home Healthcare Environment; up to 48V only
CAN ICES-3(B)/NMB-3(B)	Compliance of this PSU with Industry Canada, Class B demonstrated with a standard output load. The ICES law stipulates that system-level testing is required to demonstrate compliance with the ICES-3 emission limits with the actual system load.

Delivering leading edge, innovative power solutions for more than 30 years....

Model:GTM96300-36VV-P2



July 24, 2021

 GlobTek, Inc.	JAPAN TUV R-PSE, Cert. No. JD 50473430, to J62368-1(H30) , J55032(H29),J3000(H25)[15V or less]. Please reference the following website for guidelines on PSE regulations: http://en.globtek.com/importing-ite-and-medical-power-supplies-ac-adaptors-to-japan/
 GlobTek, Inc.	JAPAN TUV R-PSE, Cert. No. JD50473430 , to J62368-1(H30) , J55032(H29),J3000(H25)[DC15? 30V]. Please reference the following website for guidelines on PSE regulations: http://en.globtek.com/importing-ite-and-medical-power-supplies-ac-adaptors-to-japan/
 GlobTek, Inc.	JAPAN TUV R-PSE, Cert. No. JD 50473430, to J62368-1(H30) , J55032(H29),J3000(H25)[DC30? 60V]. Please reference the following website for guidelines on PSE regulations: http://en.globtek.com/importing-ite-and-medical-power-supplies-ac-adaptors-to-japan/
EFFICIENCY LEVEL 	Efficiency: complies to section 301 of Energy Independence and Security Act (EISA) complies with Energy Star tier 2 (North America), ECP tier 2 (China), MEPS tier 2 (Australia), Code of Conduct (Europe)
LPS	Limited Power Source 60950
	Morocco SDoC declaration http://www.globtek.info/certs/Morocco%20SDoC%20Declaration/
RoHS	Specifications of directive 2011/65/EU Annex VI (ROHS-2) with amendment 2015/863-EU (ROHS-3) http://www.ce-mark.com/Rohs%20final.pdf
	IEC 60601-1:2005 (Third Edition) + CORR. 1 (2006) + CORR. 2 (2007) + AM1 (2012) EN 60601-1:2006/ A1:2013+A12:2014 up to 48V only
	S-Mark Certificate EN 60950-1:2006 + A11:2009 + A1:2010 + A12:2011 +A2:2013 (http://www.intertek.com/marks/s/)
	UKCA Certification
 1Q276	Ukraine UKRSepr (Document: www.globtek.com/html/iso_certificates/GT_Ukraine.pdf)

Delivering leading edge, innovative power solutions for more than **30** years....

Model:GTM96300-36VV-P2

July 24, 2021

	Japan: Voluntary Control Council for Interference (VCCI)
	WEEE: Complies with EU 2012/19/EU (http://ec.europa.eu/environment/waste/weee/index_en.htm) Mark is on the label or Molded in the case