

Delivering leading edge, innovative power solutions for more than 30 years....

Model:GTM91120-30VV-P2(SR with EU Plug 2 pin)

July 24, 2021

GTM91120-30VV-P2(SR with EU Plug 2 pin)

Information

Model Number

GTM91120-30VV-P2(SR with EU Plug 2 pin)

Description

GTM91120-30VV-P2(SR with EU Plug 2 pin), ICT / ITE / Medical Power Supply, 60601-1-4th Ed. , Potted/Encapsulated in plastic housing, Regulated Switchmode AC-DC Power Supply AC Adaptor, , Input Rating: 100-240V~, 50-60 Hz, Europe Blades Class II, (2) Conductors, Output Rating: 30 Watts, Power rating with convection cooling (W) , 5-48V in 0.1V increments, Approvals: Fuse 60335; Book 60601; CB 60601-1; CB 60950; CB 60335; CB EN/IEC 60335-1; CE; CE; CE; China RoHS; Double Insulation; EAC; FCC; IEC 60335; IEC/EN60601-1; IEC/EN60950-1; IP68; Level V; LPS 60950; SIQ; RoHS; SIQ; SIQ; Ukraine; VCCI; WEEE;

Model Picture



Agency Documents

<http://www.globtek.info/certs/GTM91120-P2%20-P3/>

CE EC-Declaration

https://www.globtek.com/pdf/ec_declaration/a0O3a00000LvhgEAB

RoHS/RoHS2 Declaration

https://www.globtek.com/pdf/rohs_cert/a0O3a00000LvhgEAB

REACH Declaration

https://www.globtek.com/pdf/iso_certificates/REACH.pdf

Conflict Minerals Declaration

<https://www.globtek.com/pdf/conflict-minerals.pdf>

Delivering leading edge, innovative power solutions for more than **30** years....

Model:GTM91120-30VV-P2(SR with EU Plug 2 pin)

July 24, 2021

MODEL PARAMETERS

Type	Potted/Encapsulated in plastic housing
Technology	Regulated Switchmode AC-DC Power Supply AC Adaptor
Category	ICT / ITE / Medical Power Supply
Input Voltage	100-240V~, 50-60 Hz
I/P Amps (A)	1.5A
Wattage (W)	30.0
Vout Range (V)	5-48
Efficiency Level	V
Ingress Protection	IP68
Size (mm)	

Delivering leading edge, innovative power solutions for more than 30 years....

Model:GTM91120-30VV-P2(SR with EU Plug 2 pin)

July 24, 2021

ENCLOSURE

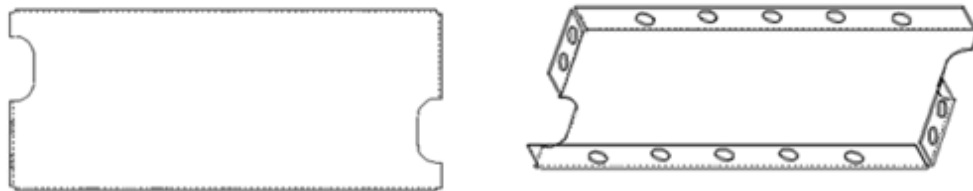
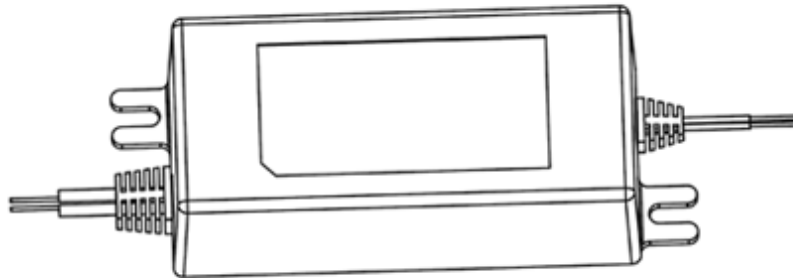
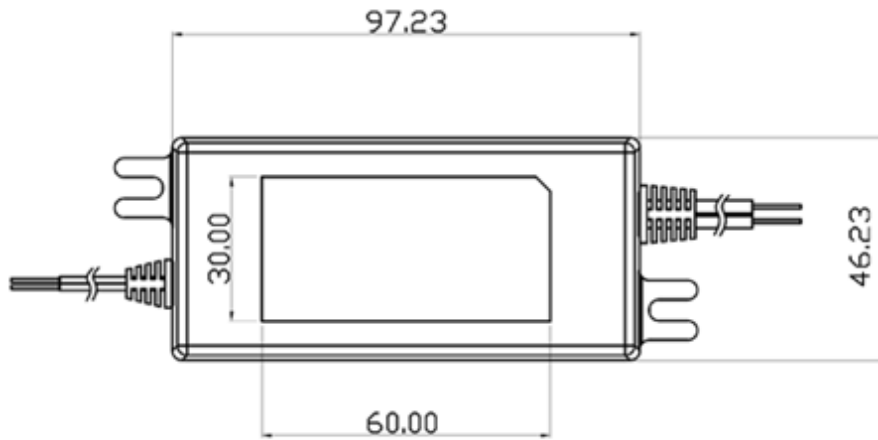

MYLAR CASE COVER INSTALLED

Delivering leading edge, innovative power solutions for more than **30** years....

Model:GTM91120-30VV-P2(SR with EU Plug 2 pin)

July 24, 2021

RATING TABLE

Model Number	Voltage	Amps(A)	Watts(W)	RFQ
GTM91120CC-3007.5-2.5-P2	5 V	4	20.00	RFQ
GTM91120-157.5-2.5-P2	5 V	3	15.00	RFQ
GTM91120-2510.5-1.5-P2	9 V	2.77	24.93	RFQ

SPECIFICATIONS

A) ELECTRICAL SPECIFICATIONS:

1. Input Voltage: Specified 90-264 Vac, Nameplate rated: 100-240Vac
2. Input Frequency: Specified 47-63 Hz, Nameplate rated 50-60Hz
3. Output Regulation: 8%- 5% measured at the output connector
4. Line Voltage Regulation: +/- 2% typical measured at full load
5. Output Ripple (Vp-p): +/-2% maximum, measured at 20 MHz bandwidth with 0.1 uf ceramic capacitor in parallel with 10 uf electrolytic capacitor connected at the end of the output connector at nominal line
Optional low ripple option available (RFP4579)
6. Turn-ON/OFF Overshoot: 5% maximum, 500uS typical recovery time for 25% to 50% step load
7. Turn-ON Delay: 3 Seconds, maximum @ full load, nominal line
08. Hold-Up Time: 5mS typical @ nominal input voltage and full load
09. Inrush Current: 60A maximum cold start @ 240Vac input
10. Switching Frequency: 100 KHz typical

B) PROTECTION

1. Over-Voltage: Protected with a Zener diode clamp across the output
2. Short Circuit: Hiccup with auto recovery
3. Over-load: Hiccup with auto recovery
4. Input Protection: Input line and neutral fusing

C) SAFETY

1. Dielectric Withstand Voltage: 5656Vdc from primary to secondary
2. Earth Leakage Current: N/A for Class II units, there is no PE Ground pin, so Earth Leakage current is not measured
3. Touch Current: Maximum allowed values: 100uA NC(Normal condition) 500uA SFC(single fault condition)

D) OTHER:

1. MTBF: 200,000 Hours @ 25°C ambient temperature
2. Operating Temperature: -10°C to 40°C ambient temperature (RFP RFI-50576)
3. Humidity: 0% to 90% relative humidity
4. Storage Temperature: -10°C to 80°C
5. Cooling: Convection
6. ROHS 2: Complies with EU 2011/65/EU and China SJ/T 11363-2006
7. For EMI suppression 28A026-0A2 Snap-on Ferrites are recommended on both input and output cables, if required.

E) ENCLOSURE

1. Housing: High impact plastic, 94V0 polycarbonate, non-vented
2. Size: 97.23 x 46.23 x 32.0 +/- 1.0 mm
3. Markings: Label and/or Pad Printed and/or Molded in the case
4. Ingress Protection: IP68, Dust Tight, No ingress of dust, complete protection against contact as well as Protected against liquid Immersion beyond 1 m

Delivering leading edge, innovative power solutions for more than **30** years....

Model:GTM91120-30VV-P2(SR with EU Plug 2 pin)

July 24, 2021

DERATING CURVE

Delivering leading edge, innovative power solutions for more than **30** years....

Model:GTM91120-30VV-P2(SR with EU Plug 2 pin)

July 24, 2021

INPUT CONFIGURATION

Description Europe Blades Class II, (2) Conductors

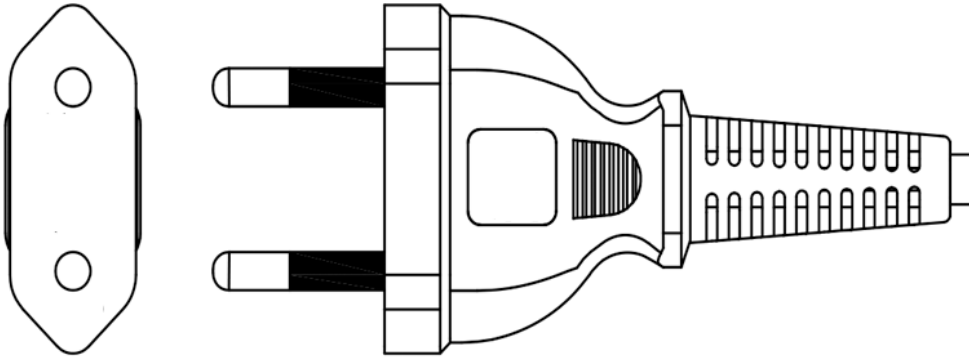

Delivering leading edge, innovative power solutions for more than 30 years....

Model:GTM91120-30VV-P2(SR with EU Plug 2 pin)

July 24, 2021

OUTPUT CONFIGURATION

Common output connector options:

 L Type (Coaxial
5.5x2.5mm plug)

 C Type (Coaxial
5.5x2.1mm plug)

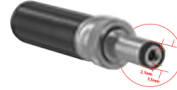
 K Type (Coaxial
3.5x1.3mm plug)

 LL Type (5.5x2.5mm
Locking 760k type)

 CL Type (5.5x2.1mm
Locking S761k type)

 ML2 Type (Molex
housing 43025-0200)

 YL3 Type
(KPPX-3P)

YL4 Type (KPPX-4P)

 EJ1/2/3/4/5 (EIAJ
RC-5320A type
connectors)

 MSB Type (Micro
USB)

 USBC Type (USB
Type C)

 Inquire for custom
design

 For a comprehensive list of options, [click here](#)







Contact GlobTek for your specific requirements or custom solutions.

Delivering leading edge, innovative power solutions for more than 30 years....

Model:GTM91120-30VV-P2(SR with EU Plug 2 pin)

July 24, 2021









Approvals

Logo	Description
	Attention Mark / Refer to operating manual for operating and service instructions
	Book 60335 up to 36 Volts
	60601-1 3rd Operating Instructions
No Logo Applicable	CB report IEC 60601-1: 2005 + CORR. 1 (2006) + CORR. 2 (2007) and or EN 60601-1:2006 3rd Edition including 2MOOP requirements
No Logo	CB Certificate IEC 60950-1:2005 (2nd Edition), Am 1: 2009, CB report IEC 60950-1:2005 (2nd Edition), Am 1: 2009 and EN 60950-1:2006 + Am 1:2010 + Am 11:2009 + Am 12:2011
No Logo Applicable	CB to 60335-1 5th Edition (Safety of Household and Similar Electrical Appliances, Part 1: General Requirements) CB Report/ Certificate IEC 60335-1:2010 Up to 36 volts only
No Logo Applicable	IEC 60335-1:2010 (Fifth Edition) incl. Corr. 1:2010 and Corr. 2:2011 + A1:2013
	CE Mark: tested to comply with EN 55032:2012+AC:2013, EN 61000-3-2:2014, EN 61000-3-3:2013, EN 55024:2010, EN 60601-1-2:2015
	CE Mark: tested to comply with EN55022:2006/A1:2007 Class B, EN610003-2, EN610003-3 including EN61000-4-2, EN61000-4-3, EN61000-4-4, EN61000-4-5, EN61000-4-6N EN61000-4-11; EMI: Complies with EN55011 CLASS B and FCC Part 15B - On label or Molded in case
	CE Mark: tested to comply with EN61000-3-2, EN61000-3-3 and EN50082-1, including EN61000-4-2, EN61000-4-3, EN61000-4-4, EN61000-4-5, EN61000-4-6, EN61000-4-8, EN61000-4-11, EN61001-1-2-2007 EMI: Complies with EN55011 CLASS B and FCC Part 15 B

Delivering leading edge, innovative power solutions for more than 30 years....

Model:GTM91120-30VV-P2(SR with EU Plug 2 pin)

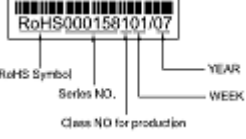
July 24, 2021

	CHINA SJ/T 11364-2014, China RoHS Chart: http://en.globtek.com/globtek-rohs.php
	
	Certification # TC RU AR46.B.75423 Custom Union of Russia, Belarus and Kazakhstan
	FCC PART 15 CLASS B
IEC/EN60335-1	IEC/EN60335-1 Up to 36 volts
IEC/EN60601-1	IEC/EN60601-1
IEC/EN60950-1	IEC/EN60950-1
	Indoor Use Only - Mark is on the label or Molded in the case
IP68	Ingress Protection: ?IP68 to IEC60529:2001 Totally dust tight and Protected against long periods of immersion under pressure
EFFICIENCY LEVEL 	Efficiency: complies to section 301 of Energy Independence and Security Act (EISA) complies with Energy Star tier 2 (North America), ECP tier 2 (China), MEPS tier 2 (Australia), Code of Conduct (Europe)
LPS	Limited Power Source 60950
RoHS	Specifications of directive 2011/65/EU Annex VI (ROHS-2) with amendment 2015/863-EU (ROHS-3) http://www.ce-mark.com/Rohs%20final.pdf
 <p>RoHS Symbol Series NO. Class NO for production YEAR WEEK</p>	Serial Number Information
 IEC/EN60335-1	SIQ IEC/EN 60335-1 (Safety of Household and Similar Electrical Appliances, Part 1: General Requirements) up to 36 volts

Delivering leading edge, innovative power solutions for more than **30** years....

Model:GTM91120-30VV-P2(SR with EU Plug 2 pin)

July 24, 2021

 IEC/EN60950-1	SIQ Mark License Certificate EN 60950-1:2006 + Am 1:2010+ Am 11:2009 + Am 12:2011
 IEC/EN60601-1	SIQ Mark License EN60601-1, 3rd edition
	UKCA Certification
 10276	Ukraine UKRSepro (Document: www.globtek.com/html/iso_certificates/GT_Ukraine.pdf)
	Japan: Voluntary Control Council for Interference (VCCI)
	WEEE: Complies with EU 2012/19/EU (http://ec.europa.eu/environment/waste/weee/index_en.htm) Mark is on the label or Molded in the case